

# **can-am**®

**QUADRY ŚREM**  
**KT RACING TEAM**  
AUTORYZOWANE CENTRUM BRP



## **CAN-AM** **ATVs**



**Accessories and Parts & Maintenance**

**2023**



# CAN-AM ATVs

## ACCESSORIES

LinQ: Easy On, Easy Off Cargo	6
Racks & Holders	11
Cargo & Storage	12
Can-Am Windshields	14
Handlebars & Mirrors	15
Seats	16
Plastic Skid Plates	17
HMWPE Skid Plates	18
Aluminum Skid Plates	19
HMWPE & Aluminum Skid Plates	21
Bumpers & Guards	22
Lights & Electrical	25
Winches	29
Hitches	31
Performance	32
Covers, Decals & Add-Ons	35
Apache Track Systems	37
ProMount Plows	40
Tires & Rims	45

## PARTS AND MAINTENANCE

Keep an Eye on These Parts	50
Genuine Parts	51
Lubricant & Oil Change Kit	56
Maintenance Products	57
Care Products	58

## CAN-AMOFFROAD.COM

© 2022 Bombardier Recreational Products Inc. (BRP). All rights reserved. ®, TM and the BRP logo are trademarks of BRP or its affiliates. All other trademarks are the property of their respective owners. BRP reserves the right to discontinue or change specifications, prices, designs, features, models or equipment without incurring obligation. Some models depicted may include optional equipment. Product performance may vary depending on weather, temperature, altitude, driving ability and driver/passenger weight. Prices, if shown, are based on the manufacturer's suggested retail price. Dealers may sell at a different price. BRP recommends that all ATV-SSV drivers take a training course. See your dealer or call the ATV Safety Institute at 1-800-887-2887 (USA) or the Canadian Safety Council at 1-613-739-1535 (Canada). ATVs and SSVs can be hazardous to operate. Never carry passengers on any ATV-SSV not specifically designed by the manufacturer for such use. All adult-model Can-Am ATVs are category G ATVs (general-use models) intended for recreational and/or utility use by an operator age 16 or older. Carefully read the vehicle's operator's guide. Follow all instructional and safety material and observe applicable laws and regulations. ATVs and SSVs are for off-road use only; never ride on paved surfaces or public roads. For your safety, the operator and passenger(s) must wear a helmet, eye protection and applicable protective clothing. Always remember that riding, alcohol and drugs don't mix. Never engage in stunt driving. Avoid excessive speed and be particularly careful on difficult terrain. Always ride responsibly and safely. See your authorized BRP dealer for details and visit can-am.brp.com. Printed in Canada.

# CUSTOMIZING MADE EASY

1

Select the model.

2

Select the package.

3

Customize color, engine, and accessories (or accessory bundles) for your vehicle.

4

Click "Save" or "Send to dealer".

If you can dream it, you can build it. And ride it. Creating a Can-Am vehicle tailor-made for our riders' needs has never been easier. Visit [CanAmOffRoad.com](http://CanAmOffRoad.com) and follow the step-by-step above.

**BUILD  
YOURS NOW**



---

# ACCESSORIES ATV

---

## BRP 2-YEAR LIMITED WARRANTY\*

For new Can-Am accessories, genuine parts, and co-branded products sold through BRP. Includes items installed by you or an authorized BRP dealer.

The limited warranty is subject to the exclusions, limitations of liabilities and all other terms and conditions of BRP's standard limited warranty. See the complete limited warranty applicable to your product, or contact your authorized Can-Am Off-Road dealer. Applicable only to BRP products purchased at authorized BRP dealers or distributors. This limited warranty may not apply to factory-installed parts and accessories. Always refer to the product-specific limited warranty. Some states and provinces do not allow for some disclaimers, limitations and exclusions and, as a result, you have other specific rights.

**We've made things super simple.**

- Check your model year
- Choose engine and model
- Learn your **PLATFORM CODE**

This **PLATFORM CODE** will let you know at a glance if the accessory is compatible with your vehicle.

## ATV ACCESSORY COMPATIBILITY GUIDE

Model year	Model	Engine configuration	Platform code
2015	Outlander L	450, 500	G2L
	Outlander	500, 650, 800, 1000	G2
	Outlander L MAX	450, 500	G2L
	Outlander MAX	500, 650, 800, 1000	G2
	6x6	650, 1000	G2
	Renegade	500, 800, 1000	G2S
2016	Outlander L	450, 570	G2L
	Outlander	570, 650, 850, 1000	G2
	Outlander L MAX	450, 570	G2L
	Outlander MAX	570, 650, 850, 1000	G2
	6x6	650, 1000	G2
	Renegade	570, 850, 1000	G2S
2017	Outlander	450, 570	G2L
	Outlander	650, 850, 1000	G2
2018	Outlander MAX	450, 570	G2L
	Outlander MAX	650, 850, 1000	G2
	6x6	650, 1000	G2
	Renegade	570, 850, 1000	G2S
2019	Outlander	450, 570	G2L
	Outlander	650, 850, 1000R	G2
2020	Outlander MAX	450, 570	G2L
	Outlander MAX	650, 850, 1000R	G2
2021	6x6	450	G2L
	6x6	650, 1000	G2
2022	6x6	450	G2L
	6x6	650, 1000	G2
2023	6x6	450	G2L
	6x6	650, 1000	G2
2023	6x6	450	G2L
	6x6	650, 1000	G2
2023	Renegade	570, 650, 850, 1000R	G2S
	Renegade	570, 650, 850, 1000R	G2S



# LINQ: EASY ON, EASY OFF CARGO

## LINQ ACCESSORIES

### Compatibility/requirements

<ul style="list-style-type: none"> <li>No tools needed: Quickly install and remove accessories by hand.</li> <li>Equip your Can-Am for specialized tasks in no time.</li> <li>Sturdy mounting system that holds up to the roughest terrain.</li> </ul>	<b>OUTLANDER 450/570</b>	<b>OUTLANDER</b>	<b>RENEGADE</b>
<b>LinQ Accessories with 16" Base</b> <ul style="list-style-type: none"> <li>LinQ anchors mounted 16 inches apart, center-to-center.</li> <li>Lower loading capacity than the LinQ with 36" base accessories.</li> <li>Can be used on Can-Am ATV and SSV vehicles, Can-Am Spyder and Ryker vehicles, Sea-Doo watercraft and Ski-Doo snowmobiles.</li> </ul>			
<b>LinQ 4.2 Gal (16 L) Cooler</b> 219400964 • Black / 295100698 • White	LinQ Adapter Plate <b>715007273</b> & LinQ Base Installation Kit <b>715008125</b>	LinQ Anchor Adapter Kit <b>715004960</b>	LinQ Luggage Rack <b>715001734</b> & LinQ Anchor Adapter Kit <b>715004960</b>  OR  LinQ Adapter Plate <b>715007274</b> & LinQ Base Installation Kit <b>715008125</b>
<b>LinQ Tool Box</b> 715008111			
<b>LinQ SR 5.5 Gal (21 L) Bag</b> 860202449			
<b>LinQ 4.5 Gal (17 L) Sport Bag</b> 860202447			
<b>LinQ Modular Box</b> 715005494 • (10 L) 715007112 • (20 L) 715006830 • (30 L)			
<b>LinQ Tool Kit</b> 715006829			
<b>LinQ Roll-Top Bag</b> 715008110			
<b>LinQ Accessories with 36" Base</b> <ul style="list-style-type: none"> <li>Mount on LinQ racks often used by Can-Am ORV vehicles.</li> <li>Higher loading capacity than the LinQ with 16" base accessories.</li> <li>Usage is limited to Can-Am ORV vehicles.</li> </ul>			
<b>LinQ 12 Gal (45 L) Cargo Box</b> 715003879	LinQ Base <b>715002350</b>	No further requirements	LinQ Luggage Rack <b>715001734</b>
<b>LinQ 23 Gal (86 L) Trunk Box</b> 715008749	No compatibility		
<b>LinQ 32 Gal (121 L) Trunk Box</b> 715001747 (2-up) 715001749 (MAX)	No compatibility		
<b>LinQ 11.5 Gal (43 L) Audio Cargo Box</b> 715003018	LinQ Base <b>715002350</b>		
<b>LinQ 8 Gal (30 L) Cooler Box</b> 715004778 • Black / 715004698 • Gray	No compatibility		
<b>LinQ Premium Storage Bag by OGIO</b> 715002923 • Black	LinQ Base <b>715002350</b>		
<b>LinQ Heavy Duty Basket</b> 715001215	LinQ Base <b>715002350</b>		
<b>LinQ Low Profile Basket</b> 715004282			
<b>LinQ Holders</b>			
<b>LinQ 4" Rack</b> 715001711 • Silver / 715001665 • Black	Not compatible <i>*Alternative 5" or 8" Rack Extensions (715001913 or 715001914) are available for G2L</i>	No further requirements	LinQ Luggage Rack <b>715001734</b>
<b>LinQ 6" (15 cm) Rack Extension</b> 715001712 • Silver / 715001671 • Black	LinQ Base <b>715002350</b>		
<b>LinQ Mounted Gear Grips</b> 715005340	LinQ Base <b>715002350</b>		
<b>LinQ Tool Holder</b> 715007358	Not compatible <i>*Alternative Gun Boot Racks (715001918 or 715001919) are available for G2L</i>		

## LinQ Accessories with 16" base

### LinQ Modular Box

G2, G2L, G2S

715005494 · (10 L) **720 zł**  
 715007112 · (20 L) **831 zł**  
 715006830 · (30 L) **923 zł**



- Allows stacking of other modular boxes to always have the right gear accessible.
- Always have the right box size to fit everything.
- Can be installed on any LinQ base with a 16" width.
- See table for installation location and requirements.

### Thermal Insert For LinQ Modular Box (10 L)

G2, G2L, G2S

219401110 **290 zł**



- Insulated liner.
- Fits very well in the LinQ Modular Box (10 L).
- Can contain five 473 ml cans or six 355 ml cans.

### LinQ Tool Kit

G2, G2L, G2S

715006829 **1 605 zł**



- Includes:
  - Cutter pliers
  - Long-nose pliers
  - Locking plier
  - Ratchet wrench 3/8" drive
  - 6" ratchet extension
  - Integrated CVT belt storage location (belt not included)
  - Long-socket 19 mm 3/8" drive - 6pts
  - Socket 18 mm 3/8" drive
  - Long-socket 17 mm 3/8" drive - 6pts
  - Socket 15 mm 3/8" drive
  - Socket 13 mm 3/8" drive
  - Socket 10 mm 3/8" drive
  - Socket 8 mm 3/8" drive
  - Combined wrench 19 mm
  - Combined wrench 18 mm
  - Combined wrench 15 mm
  - Combined wrench 13 mm
  - Combined wrench 10 mm
  - Combined wrench 8 mm
  - Socket Torx T40 3/8" drive
  - Socket Torx T30 3/8" drive
  - Socket Torx T20 3/8" drive
  - Breaker bar 3/8" drive
- See table for installation location and requirements.

### LinQ 4.2 Gal (16 L) Cooler

G2, G2L, G2S

219400964 · Black **1 882 zł**  
 295100698 · Gray



- All the benefits of LinQ—simple, fast and secure.
- Rotomolded construction for exceptional rigidity and durability.
- Premium-quality foam insulation for optimal ice retention.
- Uses LinQ mounting system (Patent US 8777531 and US 8875830).
- Easy one-second on/off tool-less system.
- See table for installation location and requirements.

### LinQ Tool Box

G2, G2L, G2S

715008111 **904 zł**



- High precision injected HDPE construction provides rigidity and durability.
- 5 gal (19 L) maximum capacity.
- Weather-resistant, sealed and lockable cover.
- Marineized for salt water purposes.
- See table for installation location and requirements.

### LinQ Roll-Top Bag

G2, G2L, G2S

715008110 **1 175 zł**



- Fully waterproof Roll-Top dry bag will securely store and confine your equipment.
- LinQ mounted using heavy-duty rigid plastic base.
- High capacity storage solution 10.6 gal (40 L).
- Bottom foam liner for additional equipment protection.
- Integrated handle for easy transportation on/off the vehicle.
- Marineized for salt water purposes.
- See table for installation location and requirements.

**SR 5.5 Gal (21 L) LinQ Bag** | G2, G2L, G2S | **860202449** **1 144 zł**



- Semi-rigid expandable bag.
- 5.5 gal (21 L) capacity.
- See table for installation location and requirements.

**LinQ 4.5 Gal (17 L) Sport Bag** | G2, G2L, G2S | **860202447** **1 058 zł**



- 4.5 gal (17 L) capacity.
- Rigid bottom, semi-rigid top.
- See table for installation location and requirements.

## LinQ Accessories with 36" base

**LinQ 12 Gal (45 L) Cargo Box** | G2 (front only for 6x6 & MAX models 2013-2014), G2L, G2S | **715003879** **1 661 zł**



- LinQ mounted for easy on, easy off installation.
- Holds cargo safely and securely while riding.
- See table for installation location and requirements.

**LinQ 23 Gal (86 L) Trunk Box** | G2 (except 6x6 models), G2L, G2S | **715008749** **1 907 zł**



- LinQ mounted for easy on, easy off installation.
- Lockable and weather-resistant.
- Holds cargo safely and securely while riding.
- Comfort pads for passenger.
- See table for installation location and requirements.

**LinQ 32 Gal (121 L) Trunk Box** | G2 (except MAX models & 6x6), G2S | **715001747**  
European Version (EC compliant) | **715001748** - No rear tail light. **2 700 zł**



- LinQ Retrofit Adapter Plate (715001334) is required for G1 models.
- Trunk Box Panels available in many colors to match your vehicle (sold separately).
- See table for installation location and requirements.

**LinQ 32 Gal (121 L) Trunk Box for Outlander Max** | G2 (MAX models only except 6x6 models)  
European Version (EC compliant) | **715001749**  
**715001750** - No rear tail light. **3 475 zł**



- Passenger comfort is ensured on active rides as well as longer recreational rides thanks to the ergonomically designed passenger padding comfort-fitted with a portion made of closed cell foam that won't absorb water.
- Very easy to embark even when driver is seated.
- Trunk Box Panels available in many colors to match your vehicle (sold separately).

**LinQ 32 Gal (121 L) Trunk Box Panels** | G2 (except 6x6 models), G2S | **329 zł**



- Color panels to match the LinQ 32 gal (121 L) Trunk Box to your vehicle.

■ <b>715001391</b> · Black	■ <b>715002985</b> · Manta Green
■ <b>715001392</b> · Yellow	■ <b>715002986</b> · Can-Am Red
■ <b>715001395</b> · Viper Red	■ <b>715006119</b> · Orange Crush
□ <b>715002481</b> · White	■ <b>715006120</b> · Squadron Green
■ <b>715002480</b> · Light Gray	■ <b>715007074</b> · Tundra Green
■ <b>715002984</b> · Octane Blue	



**LinQ 32 Gal (121 L) Trunk Box Panels**  
(Not illustrated)

EUROPEAN VERSION (EC compliant)

- Color panels to match the LinQ 32 gal (121 L) Trunk Box to your vehicle.
- No rear tail light.

**329 zł**

■ **715001397** · Black

■ **715001398** · Yellow

■ **715006124** · Viper Red

□ **715002483** · White

■ **715006122** · Manta Green

■ **715006121** · Can-Am Red

■ **715006123** · Orange Crush

**LinQ 11.5 Gal (43 L) Audio Cargo Box**

G2 (front only for 6x6 & MAX models 2013-2014), G2L, G2S

**715003018**

**4 176 zł**



- Mounts on/off easily to hold/carry cargo safely and securely.
- The Bluetooth enabled receiver and 6.5" (16.5 cm) speakers are smartly concealed and integrated in the cover.
- Automatic shut-off function protects your battery by turning the system off after 10 minutes of inactivity.
- Backlit control panel perfect for night riding.
- Water-resistant speakers.
- Delivers the best sound quality on the market to sweeten your ride courtesy of a built-in full range high-efficiency amplifier.
- See table for installation location and requirements.

**LinQ 8 Gal (30 L) Cooler Box**

G2 (except 6x6 models), G2S

■ **715004778** · Black  
■ **715004698** · Gray

**2 270 zł**



- LinQ mounted for easy on, easy off installation.
- Rotomolded construction provides exceptional rigidity and durability.
- Premium-quality foam insulation for optimal ice retention.
- Integrated, fully-removable compartment protects food.
- Robust rubber latches keep the cover tightly closed.
- Weather-resistant.
- Convenient drain plug.
- See table for installation location and requirements.

**LinQ Premium Storage Bag by OGIO**

G2 (except 6x6 models), G2L, G2S

■ **715002923** · Black

**2 233 zł**



- LinQ mounted for easy on, easy off installation.
- Holds cargo safely and securely while riding.
- See table for installation location and requirements.

**LinQ Low Profile Basket**

G2, G2L (front only for MAX & 6x6 models), G2S

**715004282**

**1 064 zł**



- Low profile, open basket increases cargo space.
- Perfect for easy access to tools, rope, winch and plow accessories.
- Multiple bungee cord and tie-down anchor points.
- Made of impact-resistant injected polypropylene.
- See table for installation location and requirements.

**LinQ Heavy-Duty Basket**

G2, G2L (front only for MAX & 6x6 models), G2S

**715001215**

**1 390 zł**



- Made of high-strength, low-alloy steel.
- LinQ mount for easy on, easy off installation.
- Can be placed on both front and back racks of vehicle.
- See table for installation location and requirements.

**Large Cargo Box**

G2, G2L (except 6x6)

**715007001**

**3 217 zł**



- Rear bed to carry large items.
- Anchor points (D-ring), LinQ fixtures for tool holder, and marks to allow the installation of a 16" accessory.
- Also has a mat for the floor and slot to enable the installation of a divider and a slot for a divider to close the recess on the rear vertical lip.
- It is installed on ATV platforms through the LinQ system and hooks to make it easily installable and removable.

## LinQ Holders

### LinQ Tool Holder

G2, G2S, G2L

715007358 **282 zł**



- Ultra-versatile tool holder.
- Convenient swivel-latch allows tools to be stored in any orientation.
- Sold in pairs.

### LinQ Gear Grips

G2, G2S, G2L

715005340 **628 zł**



- Durable and flexible grips provide a custom fit for a variety of items from 1" to 4" (2.5 cm to 10 cm) in diameter.
- Heavy-duty design for carrying bows, fishing poles, rakes, farm tools and more.
- Quick-release button opens grip quickly for easy access to gear.
- Heavy-duty base system built for the toughest adventures.
- Make transporting your tools a snap by combining the Gear Grips with the LinQ System.
- 360° orientation.
- Sold in pairs.

## LinQ Mounting

### LinQ Anchor Adapter Kit

G2, G2S

715004960 **394 zł**



- Allows the installation of accessories with LinQ base of 16" on LinQ racks.
- Tool-less installation and removal.
- For G2S, the LinQ Luggage Rack (715001734) is required for installation.

### LinQ Base

G2L

715002350 **127 zł**



- Made of polypropylene glass fiber.
- Allows you to install LinQ accessories.
- Sold in pack of 4.

### LinQ Lock

G2, G2S, G2L,

860201968 **317 zł**



- Simple way to securely lock most LinQ accessories.
- Lock cover protects lock from the elements.
- Corrosion resistant.
- Pack of 1, includes 2 keys.
- Not compatible with LinQ 4.2 US gal (16 L) Cooler, LinQ Tool Box, LinQ Tool Holder and LinQ Gear Grips.

### LinQ Replacement Parts

715001707 **155 zł**



- Unique mounting fastener usable on any LinQ System accessory.
- Tool-less installation and removal.
- Sold in pairs.

# RACKS & HOLDERS

<b>LinQ Rack Extension – 4" (10 cm)</b>	G2, G2S	■ 715001711 · Silver <b>1 200 zł</b> ■ 715001665 · Black
---	---------	---



- Fits front or rear.
- Strong and durable.
- Helps keep cargo securely in place.
- Easy and tool-less installation thanks to the LinQ System.
- Anti-corrosion coating with durable powder coat finish.
- LinQ Luggage Rack (715001734) is required for G2S.

<b>LinQ Rack Extension – 6" (15 cm)</b>	G2, G2S	■ 715001712 · Silver <b>1 230 zł</b> ■ 715001671 · Black <b>1 273 zł</b>
---	---------	---



- Fits front or rear.
- Strong and durable.
- Helps keep cargo securely in place.
- Easy and tool-less installation thanks to the LinQ System.
- Anti-corrosion coating with durable powder coat finish.
- LinQ Luggage Rack (715001734) is required for G2S.

<b>Rack Extension – 5" (13 cm)</b>	G2L	<b>715001913 707 zł</b>
------------------------------------	-----	-------------------------



- Fits front or rear.
- Made of carbon steel.
- Provides tie-down points to secure cargo on racks.
- Easy installation on tubular rack.
- Anti-corrosion coating with durable powder coat finish.

<b>Rack Extension – 8" (20 cm)</b>	G2L	<b>715001914 824 zł</b>
------------------------------------	-----	-------------------------



- Fits front or rear.
- Made of carbon steel.
- Provides tie-down points to secure cargo on racks.
- Easy installation on tubular rack.
- Anti-corrosion coating with durable powder coat finish.

<b>LinQ Luggage Rack</b>	G2S (except X mr models)	<b>715001734 1 624 zł</b>
--------------------------	--------------------------	---------------------------



- Bolt-on rack.
- Enables use of LinQ mounted accessories on the G2S.

<b>LinQ Base Plate</b>	G2L	<b>715007273 584 zł</b>
------------------------	-----	-------------------------



- Enables use of 16" wide LinQ base accessories on G2L to extend cargo options and journey opportunities.
- Requires LinQ base kit (715008125).

<b>LinQ Base Plate</b>	G2S	<b>715007274 757 zł</b>
------------------------	-----	-------------------------



- Enables use of 16" wide LinQ base accessories on G2S to extend cargo options and journey opportunities.
- Requires LinQ Base Kit (715008125).

<b>Gun Boot Rack</b>	G2L (except MAX models)	<b>715001918</b>	<b>800 zł</b>
	G2L (MAX models only)	<b>715001919</b>	<b>800 zł</b>



- Made of steel.
- Designed for the tubular rack.
- For use with Gun Boot 6.0 Impact by Kolpin.
- Can be mounted to either side of the vehicle.

<b>Gun Boot 6.0 Impact<sup>†</sup> By Kolpin<sup>†</sup></b>	G2, G2L	<b>715001419</b>	<b>560 zł</b>
--	---------	------------------	---------------



- Extra room for pistol-grip-type weapons and small bipods.
- Easily fits firearms up to 51" (130 cm) in total length.
- Provides ample room for 2 3/8" (60 mm) scopes.
- Hatchback design allows easy access.
- Ergonomically designed handle and molded attachment points for sling.
- Snap-close cover with locking capability.
- Designed to accommodate left and right hand bolt-action rifles and shotguns.
- Includes removable, shock absorbing foam and nylon Impact liner for superior interior protection.
- Requires appropriate mounting kit for installation.

<b>LinQ Gun Boot Rack</b> <i>(Not illustrated)</i>	G2 (except MAX, 6x6 & X mr 1000)	<b>715002112</b>	<b>954 zł</b>
	G2 (MAX & X mr 1000 models only)	<b>715002113</b>	<b>867 zł</b>

- This lightweight Gun Boot Rack can be mounted on either side of your Outlander using the tool-less LinQ System.
- For use with Gun Boot 6.0 Impact by Kolpin.

<b>Multi-Fit Holder</b>	G2, G2L	<b>715002354</b> · Single	<b>325 zł</b>
		<b>715001945</b> · Double	<b>462 zł</b>



- Open U-shaped bracket for carrying tools (shovel, axe) and hunting weapons (rifle, bow) that are safely secured, but easily accessible.
- Easy installation on tubular rack, extension racks, basket or bumpers.
- For G2, the LinQ Rack Extension (715001711) is required.
- Sold in pairs.

<b>LinQ Gear Grips</b>	G2L	<b>715001421</b>	<b>664 zł</b>
------------------------	-----	------------------	---------------



- Durable, flexible grips cushion and protect while providing a custom fit for a variety of items from 1" to 4" (2.5 cm to 10 cm) in diameter.
- Heavy-duty design for carrying bows, fishing poles, rakes, farm tools and more.
- Quick-release button opens grip quickly for easy access to gear.
- Heavy-duty base system built for the toughest adventures.
- Easy installation on tubular racks, extension racks, brackets or bumpers.
- Sold in pairs.

## CARGO & STORAGE

<b>Log Bars</b>	G2 (6x6 models only)	<b>715001987</b>	<b>5 990 zł</b>
-----------------	----------------------	------------------	-----------------



- Log bars allow you to convert the cargo bed into a perfect transport space for 4' (120 cm) timber.
- The driver's safety is guaranteed by the protective front screen.

<b>Hard Top</b>	G2 (6x6 models only)	<b>715002394</b>	<b>5 541 zł</b>
-----------------	----------------------	------------------	-----------------



- The hard top provides a 116 gal (440 L) cargo box.
- Locking secures your belongings.
- The cover raises assisted by gas cylinders.







<b>Side Walls &amp; Tailgate</b>	G2 (6x6 models only)	<b>715005153</b>	<b>5 775 zł</b>
----------------------------------	----------------------	------------------	-----------------



- Allows for a quick and easy conversion of the cargo bed into a trunk with plenty of room.
- Rotationally molded walls provide extreme durability for hard work - in all conditions.

<b>Cargo Box Pool</b>	G2L (6x6 models only)	<b>715005256</b> <b>1 931 zł</b>
	<ul style="list-style-type: none"> <li>Transforms the flatbed into a large capacity cargo box for increased loading possibilities.</li> <li>Made of durable formed HDPE and shaped to maximize cargo space.</li> <li>Allows access to vehicle's water-resistant rear compartment.</li> <li>Designed for perfect fit and easy installation.</li> </ul>	
<b>Tailgate Extension/Divider</b>	G2 (6x6 models only)	<b>715002017</b> <b>2 632 zł</b>
	<ul style="list-style-type: none"> <li>The sturdy tailgate extension provides a 10" (25 cm) extension to the cargo space.</li> <li>Thanks to the longer cargo bed, even large loads pose no problem.</li> <li>With the help of LinQ quick locks, the extension also acts as a solid space divider for the cargo bed.</li> </ul>	
<b>Tarpaulin</b>	G2 (6x6 models only)	<b>715002416</b> <b>2 036 zł</b>
	<ul style="list-style-type: none"> <li>Fitted to cover all of the items in your cargo box thoroughly.</li> <li>Prevents splash from entering cargo box.</li> <li>Easily removable for quick access.</li> </ul>	
<b>18 Gal (70 L) Utility Box</b>	G2 (6x6 models only)	<b>715001999</b> <b>2 878 zł</b>
	<ul style="list-style-type: none"> <li>Wherever you go and whatever you do, this handy 18 gal (70 L) utility box is your mobile storage.</li> <li>The lid keeps your equipment safe from the elements in all conditions.</li> <li>Slides under the flatbed with handles for easy access.</li> </ul>	
<b>Cargo Box Net</b>	G2 (6x6 models only)	<b>715001371</b> <b>341 zł</b>
	<ul style="list-style-type: none"> <li>Solid net designed to hook to the bottom of the cargo box for secure and compact confinement of your cargo.</li> </ul>	
<b>Soft Storage Bag</b>	G2, G2L, G2S	<b>715003759</b> <b>923 zł</b>
	<ul style="list-style-type: none"> <li>3-section bag.</li> <li>Transport gear in a weatherproof bag.</li> <li>11.8 gal (45 L) capacity soft cargo bag designed with vehicle's rack in mind to maximize potential storage.</li> <li>LinQ Luggage Rack (715001734) is required for G2S.</li> </ul>	
<b>Storage 2.6 Gal (10 L) Bag</b>		<b>269502121</b> <b>194 zł</b>
	<ul style="list-style-type: none"> <li>Roll-Top dry bag for fully protecting your cargo from the elements.</li> <li>Fits in rear compartment of your vehicle.</li> </ul>	

# CAN-AM WINDSHIELDS

<b>Deluxe Fairing</b>		G2 (except X mr & 6x6), G2L	<ul style="list-style-type: none"> <li>■ <b>715001232</b> · Black</li> <li>■ <b>715000935</b> · Yellow 2000</li> <li>■ <b>715002479</b> · Light Gray</li> </ul>	<ul style="list-style-type: none"> <li>■ <b>715006125</b> · Squadron Green</li> <li>■ <b>715007073</b> · Tundra Green</li> </ul>	<b>1 329 zł</b>
	<ul style="list-style-type: none"> <li>• Innovative, richly featured wind protection.</li> <li>• Quick tool-less removal once base brackets are mounted on handlebar.</li> <li>• Two cup holders.</li> <li>• Ready for GPS mounting kit.</li> </ul>	<ul style="list-style-type: none"> <li>• Optional mirrors and auxiliary lighting.</li> <li>• Requires low, high or extra high windshield.</li> <li>• Tapered Handlebar Adapter Kit is required for vehicles with 1 1/8" (28 mm) tapered aluminum handlebars.</li> <li>• Does not fit T3 models.</li> </ul>			
<b>Camo Decals for Black Deluxe Fairing</b> <i>(Not illustrated)</i>		Deluxe Fairing	<ul style="list-style-type: none"> <li>■ <b>715002976</b> · Mossy Oak Break-Up Country Camo</li> </ul>	<ul style="list-style-type: none"> <li>■ <b>715001684</b> · Next G-1 Vista Camo</li> </ul>	<b>225 zł</b> <b>225 zł</b>
		• Camo pattern perfectly matches your camo vehicle.			
<b>Tapered Handlebar Adapter Kit</b> <i>(Not illustrated)</i>		Deluxe Fairing			<b>183 zł</b>
		• Required to install Deluxe Fairing on an Outlander X-TP and on any vehicle equipped with 1 1/8" (28 mm) tapered aluminum handlebars.			
<b>Extra High Windshield</b>		Deluxe Fairing	<b>715000936</b>	<b>615 zł</b>	
	<ul style="list-style-type: none"> <li>• 16" (41 cm) windshield provides the ultimate protection against the elements while touring.</li> <li>• For wind protection and winter applications.</li> <li>• Tool-less installation and replacement.</li> </ul>				
<b>High Windshield</b>		Deluxe Fairing	<b>715001211</b>	<b>443 zł</b>	
	<ul style="list-style-type: none"> <li>• 11" (28 cm) high, for wind protection and winter applications.</li> <li>• Tool-less installation and replacement.</li> </ul>				
<b>Low Windshield</b>		Deluxe Fairing	<b>715001227</b>	<b>375 zł</b>	
	<ul style="list-style-type: none"> <li>• 6" (15 cm) windshield allows you to keep your vehicle looking sporty while giving you some protection from the elements and the possibility of enjoying directional lighting.</li> <li>• Tool-less installation and replacement.</li> </ul>				
<b>Accessories</b>					
<b>Auxiliary Windshield Lighting</b>		Deluxe Fairing	<b>715003115</b>	<b>1 999 zł</b>	
	<ul style="list-style-type: none"> <li>• 2 premium LED spots for Deluxe Fairing for both increased output and directional lighting.</li> <li>• 1,800 lumens.</li> <li>• 2 x 10W LED Cree light kit.</li> <li>• Long-range illumination up to 350' (107 m), drawing less than 1 amp per light.</li> </ul>				
<b>Deluxe Mirror Kit</b>		Deluxe Fairing	<b>715002353</b>	<b>369 zł</b>	
	<ul style="list-style-type: none"> <li>• Improved mounting system.</li> <li>• Wide rear view.</li> <li>• Perfect fit with your Deluxe Fairing.</li> </ul>				

## Windshield Kits

### Extra High Windshield Kit

G2, G2L, G2S (except X mr models)

**715003023** **1 446 zł**



- Made of polycarbonate with integrated vent to reduce air turbulence and rumble noise at high speeds for a quieter and smoother ride.
- Quick tool-less removal once base brackets are mounted on handlebar.
- Fits straight and tapered handlebars.
- Improved design for enhanced rigidity.
- Steering Cover (709400939) is required for XT and Mossy Oak models.
- 16" (41 cm) windshield.
- For ultimate wind protection and winter applications.

### High Windshield Kit

G2, G2L, G2S (except X mr models)

**715006382** **1 261 zł**



- Made of polycarbonate with integrated vent to reduce air turbulence and rumble noise at high speeds for a quieter and smoother ride.
- Quick tool-less removal once base brackets are mounted on handlebar.
- Fits straight and tapered handlebars.
- Improved design for enhanced rigidity.
- Steering Cover (709400939) is required for XT and Mossy Oak models.
- 11" (28 cm) windshield.
- For wind protection and winter applications.

### Low Windshield Kit

G2, G2L, G2S (except X mr models)

**715003021** **1 021 zł**



- Made of polycarbonate with integrated vent to reduce air turbulence and rumble noise at high speeds for a quieter and smoother ride.
- Quick tool-less removal once base brackets are mounted on handlebar.
- Fits straight and tapered handlebars.
- Improved design for enhanced rigidity.
- Steering Cover (709400939) is required for XT and Mossy Oak models.
- 6" (15 cm) windshield.
- Allows you to keep your vehicle looking sporty while giving you some protection from the elements.

## HANDLEBARS & MIRRORS

### Handlebar Wind Deflectors

G2, G2L, G2S

**155 zł**



- Rugged injected plastic construction with Can-Am logo.
- Include removable cap for air flow adjustment.
- Mounting kit sold separately.

- |   |   |
|---|---|
|  <b>715000525</b> · Black / Yellow     |  <b>715003813</b> · Orange / Black         |
|  <b>715000537</b> · White / Black      |  <b>715003814</b> · Octane Blue / Black    |
|  <b>715001706</b> · Black / Black      |  <b>715006117</b> · Squadron Green / Black |
|  <b>715003811</b> · Can-Am Red / Black |  <b>715006118</b> · Viper Red / Black      |
|  <b>715003812</b> · Manta Green/Black  |   |

### Passenger Wind Deflectors

G2 and G2L (MAX models only)

**715001669** **480 zł**



- These wind deflectors fit on the passenger handles and provide greater comfort while riding.
- Easy to install and remove.

### Full Wrap Aluminum Mounting Kit

G2, G2L, G2S

**715001378** **548 zł**



- Lightweight black die cast aluminum construction.
- Includes complete hardware.
- Handlebar wind deflectors sold separately.

### Aluminum Tapered Handlebar

G2, G2L, G2S

**715000550** **615 zł**



- 7/8" - 1 1/8" (22 mm - 28 mm) tapered handlebar made of 6061-T6 aluminum.
- Includes all hardware, center steering foam and cover.

<b>Xt Handlebar Protector Kit</b>	G2, G2L	<b>703100352</b>	<b>577 zł</b>
-----------------------------------	---------	------------------	---------------



- Not compatible with Mud Strap (715003053).

<b>Mirrors Left – 3/8" (10 mm)</b>	G2, G2L, G2S	<b>708200963</b>	<b>159 zł</b>
------------------------------------	--------------	------------------	---------------



- True vision surface 5" x 3" (13 cm x 8 cm).
- Matte finish.
- Stem includes 3/8" (10 mm) thread.
- Bracket (715000190) is required for installation on DS 450.
- Bracket not required for installation on Outlander and Renegade.

<b>Mirrors Right – 3/8" (10 mm)</b> <i>(Not illustrated)</i>	G2, G2L, G2S	<b>709400523</b>	<b>166 zł</b>
---	--------------	------------------	---------------

- True vision surface 5" x 3" (13 cm x 8 cm).
- Matte finish.
- Stem includes 3/8" (10 mm) thread.
- Bracket (715000190) required except for vehicles with right hand brake.

<b>Handlebar Mirrors</b>	G2, G2L, G2S	<b>715005366</b>	<b>353 zł</b>
--------------------------	--------------	------------------	---------------



- Adjustable handlebar mounted convex mirrors.
- The convex surface allows improved visibility with a wider field of view.
- Doesn't require a windshield or fairing to be mounted.

## SEATS

<b>Driver Backrest</b>	G2L (except MAX models)	<b>715003941</b>	<b>1 353 zł</b>
	G2 (except 6x6 & MAX models)	<b>715003940</b>	<b>1 329 zł</b>
	G2 (6x6 models only, except MAX)	<b>715003611</b>	<b>1 200 zł</b>



- Provides the rider's back with that extra support that makes riding that extra mile way more comfortable.
- Adjusts horizontally to match the driver's height and preference.
- Mounts and locks in firmly onto the vehicle.

<b>Outlander Max Passenger Seat Kit</b>	G2 2015 & up, G2L (MAX models only)	<b>715002373</b>	<b>3 604 zł</b>
---	-------------------------------------	------------------	-----------------



- Perfect to replace used or damaged passenger seat.

<b>Heavy-Duty Seat Cover</b>	G2, G2L	<b>715007212</b>	<b>286 zł</b>
------------------------------	---------	------------------	---------------



- Heavy-duty materials to cover and protect the seat.
- Abrasion- and tear-resistant.
- Simply installs by stretching around the original seat; the elastic holds the cover securely in place.



# PLASTIC SKID PLATES

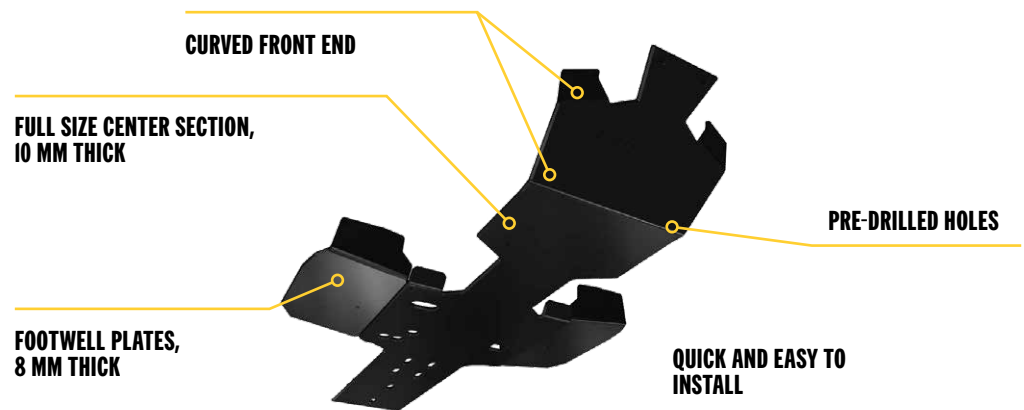
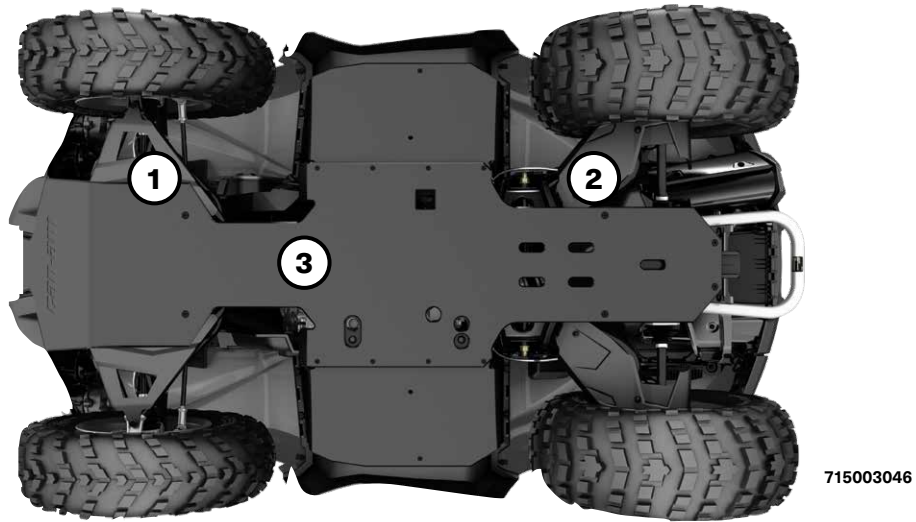

Our Plastic Plates glide smoothly and silently over obstacles, offering great protection in rough terrain. Made of abrasion-resistant thermoformed High Molecular Weight Polyethylene (HMWPE).

- Lighter than aluminum.

Offer your Outlander & Renegade the full protection kit or get them individually	OUTLANDER	OUTLANDER MAX	OUTLANDER 6X6	G2, G2S	G2L	G2L MAX
<b>INDIVIDUAL PLASTIC SKID PLATES</b>						
① A-ARM PROTECTORS G2	715002924 <b>661 zł</b>	715002924 <b>661 zł</b>	715002924 <b>661 zł</b>	715002924 <b>661 zł</b>	—	—
② TRAILING ARM PROTECTORS G2	715002925 <b>592 zł</b>	—	715002925 <b>592 zł</b>	715002925 <b>592 zł</b>	—	—
③ PLASTIC SKID PLATE G2	715006019 <b>1 706 zł</b>	715006020 <b>1 754 zł</b>	715005290 <b>2 916 zł</b> 715005320 (MAX) <b>2 916 zł</b>	—	715006115 <b>1 706 zł</b>	715006116 <b>1 754 zł</b>

# HMWPE SKID PLATES

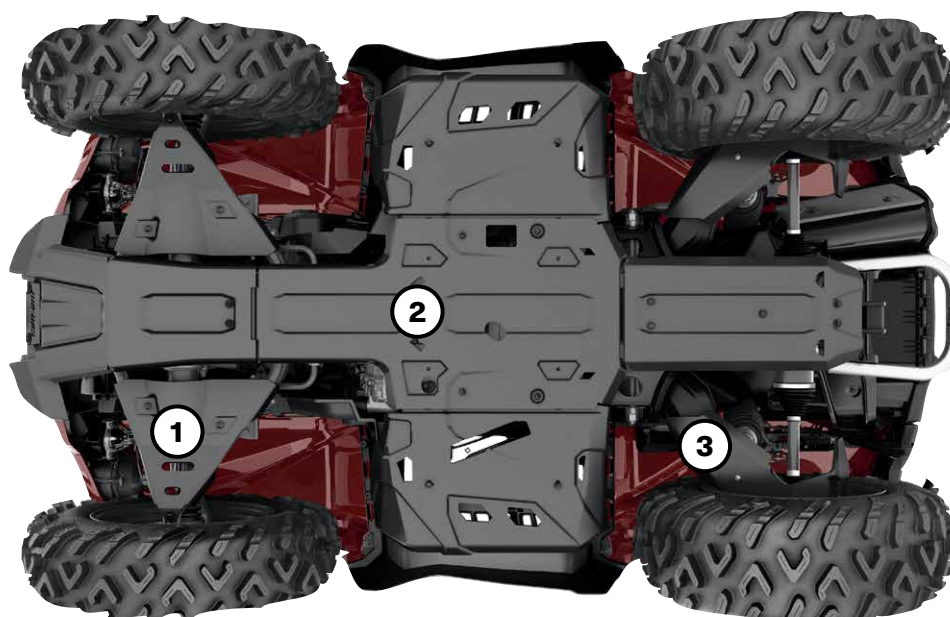

Our plastic plates glide smoothly and silently over obstacles, offering great protection in rough terrain. Made of 1/4" (6 mm) thick abrasion-resistant thermoformed High Molecular Weight Polyethylene (HMWPE).

- Lighter than aluminum.
- Superior stress crack resistance.
- High impact strength.

## OUTLANDER, RENEGADE

G2		G2L		G2S	
2016 & Prior		2017-2018		2019 & Up	
Except MAX & X mr 1000R models	MAX & X mr 1000R models only	Except Max & X mr 1000R models	MAX & X mr 1000R models only	Except MAX & X mr 1000R models	MAX & X mr 1000R models only
				Except MAX models	MAX models only

### HMWPE Skid Plate Protection Kit

715004214	715004215	715004209	715004210	715004806	715004807	715004211	715004212	715004213	715004809
-----------	-----------	-----------	-----------	-----------	-----------	-----------	-----------	-----------	-----------

### Individual HMWPE Skid Plates

① A-Arm Protectors	715002924	715002924	715002924	715002924	715004822	715004822	715002924	715002924	715002924	715004822
② Underbelly Plates <i>Footwell portion not compatible with Renegade X mr</i>	715002926	715002927	715002926	715002927	715002926	715002927	715002928	715002929	715002974	715002974
③ Trailing Arm Protectors	-	-	715003466	715003466	715004823	715004823	715003466 (2015 to 2020 models only)	715003466 (2015 to 2020 models only)	715003466	715004823

715002924 661 zł

715002926 2 383 zł

715002927 2 511 zł

715002928 2 749 zł

715003466 661 zł

715002929 2897 zł

715004806 2 383 zł

715004822 661 zł

715004823 661 zł

715002974 2 749 zł

# ALUMINUM SKID PLATES



For ultimate durability and strength, all our Aluminum Skid Plates are made with 3/16" (4.5 mm) thick High Strength 5052 H32 Aluminum.

- Ultimate durability.
- High strength.

## OUTLANDER

	G2						G2L	
	2016 & prior		2017-2018		2019 & up		Any year	
	Except MAX & X mr 1000R models	MAX & X mr 1000R models only	Except MAX & X mr 1000R models	MAX & X mr 1000R models only	Except MAX & X mr 1000R models	MAX & X mr 1000R models only	Except MAX models	MAX models only
<b>Aluminum Skid Plate Protection Kit</b>	715002137	715002138	715004197	715004198	715004804	715004805	715004199	715004200
<b>Individual Aluminum Skid Plates</b>								
① A-Arm Protectors	715001667	715001667	715001667	715001667	715004820	715004820	715001667	715001667
② Front Skid Plate	715000926	715000926	715000926	715000926	715000926	715000926	715001906	715001906
③ Central Skid Plate	715002078	715002078	715002078	715002078	715002078	715002078	715002078	715002078
④ Footwell Protector Plates	715000922	715000922	715000922	715000922	715000922	715000922	715000922	715000922
⑤ Trailing Arm Protectors	—	—	715008595	715008595	715004821	715004821	715008595	715008595
⑥ Rear Differential Protectors	715000920	715000920	715000920	715000920	715000920	715000920	715000920	715000920
⑦ Rear Skid Plate	715002028	715002029	715002028	715002029	715002028	715002029	715002028	715002029

715001667 746 zł  
715000926 421 zł  
715002078 608 zł  
715000922 778 zł  
715000920 357 zł

715004820 741 zł  
715008595 1 027 zł  
715004821 688 zł

# ALUMINUM SKID PLATES



For ultimate durability and strength, all our Aluminum Skid Plates are made with  $\frac{3}{16}$ " (4.5 mm) thick High Strength 5052 H32 Aluminum.

- Ultimate durability.
- High strength.

## RENEGADE

### G2S

	2016 & prior	2017-2018	2019 & up
<b>Aluminum Skid Plate Protection Kit</b>			
<i>Not compatible on X mr models</i>	715002139	715004201	715004808
<b>Individual Aluminum Skid Plates</b>			
② A-Arm Protectors	715001667	715001667	715004820
② Front Skid Plate	715000925	715000925	715000925
③ Central Skid Plate	715002078	715002078	715002078
④ Footwell Protector Plates <i>Not compatible on X mr models</i>	715001359	715001359	715001359
⑤ Trailing Arm Protectors	715001129	715008595	715004821
⑥ Rear Differential Protectors	715000920	715000920	715000920
⑦ Rear Skid Plate	715002028	715002028	715002028

715001667 746 zł

715004820 741 zł

715000925 421 zł

715002078 608 zł

715001359 1 064 zł

715001129 775 zł

715000920 357 zł

715002028 421 zł

# HMWPE & ALUMINUM SKID PLATES

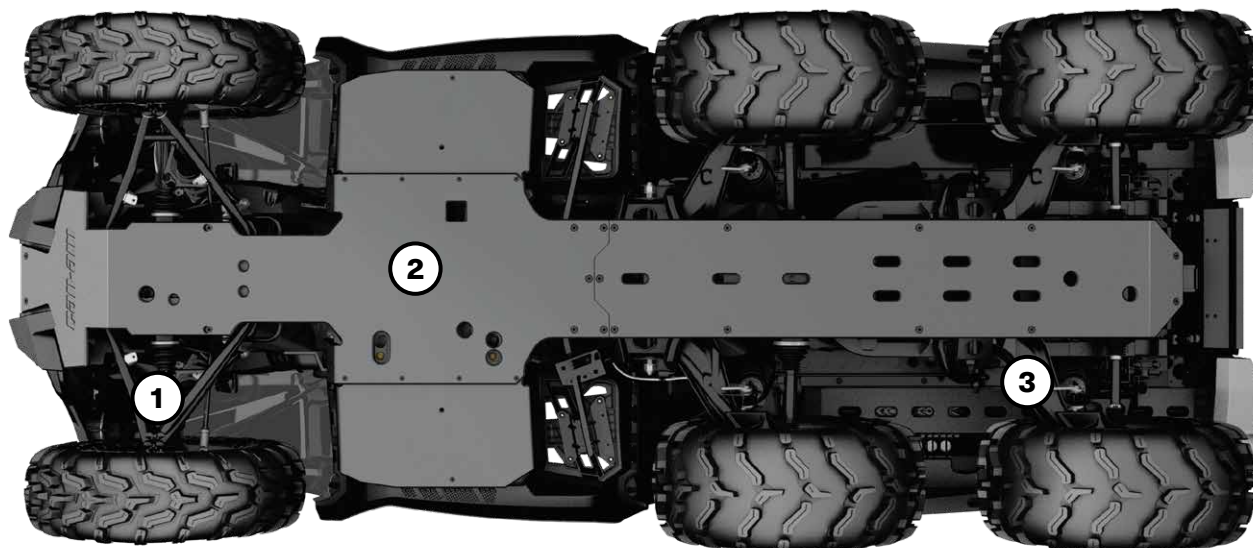

Our Plastic and Aluminum Plates glide smoothly and silently over obstacles, offering great protection in rough terrain.

## HMWPE

Made of ¼" (6 mm) thick abrasion resistant thermoformed High Molecular Weight Polyethylene (HMWPE).

- Lighter than aluminum.
- Superior stress crack resistance.
- High impact strength.

## ALUMINUM

Made with High Strength ¾" (4.5 mm) thick 5052 H32 Aluminum.







- Ultimate durability.
- High strength.

## OUTLANDER 6X6

	G2 6x6			G2L 6x6
	2016 & prior	2017 - 2018	2019 & up	Any year
<b>Individual HMWPE Skid Plates</b>				
① HMWPE A-Arm Protectors	715002924 661 zł	715002924 661 zł	715004822 661 zł	715002924 661 zł
② HDPE Full Underbelly Skid Plate	715005290 (except Max) 2 916 zł	715005290 2 916 zł	715005290 (except Max) 2 916 zł	715004987 (except MAX) 2 860 zł
	715005320 (Max Only) 2 916 zł	715005320 2 916 zł	715005320 (Max Only) 2 916 zł	715005259 (Max Only) 2 916 zł
③ HMWPE Trailing Arm Protectors	-	715003466 2 214 zł	715004823 661 zł	715003466 (2020 models & prior only) 2 214 zł
<b>Individual Aluminum Skid Plates</b>				
① Aluminum A-Arm Protectors	715001667 746 zł	715001667 746 zł	715004820 746 zł	715001667 746 zł
② Aluminum Full Underbelly Skid Plate				
③ Aluminum Trailing Arm Protectors		715008595 1 027 zł	715004821 688 zł	715008595 1 027 zł

# BUMPERS & GUARDS

## Bumpers

<b>Expedition Front Bumper</b>	G2, G2L (except X mr models & X xc models 2022 & up)	<b>715007233</b> <b>1 513 zł</b>
	<ul style="list-style-type: none"> <li>• Made of 1.5" profiled steel tubes for complete protection of the vehicle's front.</li> <li>• Protects and doesn't obstruct the vehicle's headlights.</li> <li>• Integrated mounting spots for lights.</li> <li>• Inside and outside anticorrosion coating with a durable powder coat finish.</li> </ul>	
<b>Expedition Rear Bumper</b>	G2, G2L	<b>715007234</b> <b>1 390 zł</b>
	<ul style="list-style-type: none"> <li>• Made of 1.5" profiled steel tubes for complete protection of the vehicle's rear.</li> <li>• Protects and doesn't obstruct the vehicle's taillights.</li> <li>• Inside and outside anticorrosion coating with a durable powder coat finish.</li> <li>• G2 base and DPS rear bumper installation requires 705008164 and 705008165.</li> </ul>	
<b>NEW X mr Front Bumper</b>	G2S 2023 & up	<b>715008198</b> <b>1 501 zł</b>
	<ul style="list-style-type: none"> <li>• Enhanced vehicle front protection. Required as a mounting point for Radiator Relocator (715008898).</li> </ul>	
<b>XT Front Bumper</b>	G2	<b>715004837</b> <b>1 089 zł</b>
	<ul style="list-style-type: none"> <li>• Provide additional protection against obstacles.</li> <li>• Tough and durable, can be added on base Outlander model to convert vehicle into XT model.</li> <li>• Standard on XT, XT-P, Mossy Oak and Limited models.</li> <li>• Large tube construction with textured black finish and metal corners.</li> </ul>	
<b>XT Rear Bumper</b>	G2	<b>715004920</b> <b>1 089 zł</b>
	<ul style="list-style-type: none"> <li>• Provide additional protection against obstacles.</li> <li>• Tough and durable, can be added on base Outlander model to convert vehicle into XT model.</li> <li>• Standard on XT, XT-P, Mossy Oak and Limited models.</li> <li>• Large tube construction with textured black finish and metal corners.</li> </ul>	
<b>XT Front Bumper</b>	G2L	<b>715001910</b> <b>812 zł</b>
	<ul style="list-style-type: none"> <li>• Winch compatible.</li> <li>• Large tube construction.</li> <li>• Protects vehicle against obstacles.</li> <li>• Standard on XT models.</li> </ul>	
<b>XT Rear Bumper</b>	G2L	<b>715001911</b> <b>640 zł</b>
	<ul style="list-style-type: none"> <li>• Large tube construction.</li> <li>• Protects vehicle against obstacles.</li> <li>• Standard on XT models.</li> </ul>	

<b>Extreme Front Bumper</b>	G2	715001286*	1 575zł
	G2L	715004279	1 452zł



- Ultra-sturdy build.
- Enhances front-vehicle protection.
- Compatible with XT Front Bumper.
- Fits the Apache™ 360 Track System (when side panels are removed).
- Not compliant with T-category models.
- \*Not compatible with Front Hitch.

<b>Complete Rancher Protection Kit</b>	G2, G2L (except X mr & 6x6 models)	715003463	3 459zł
--	------------------------------------	-----------	---------



- These heavy-duty bumpers and fender guards are designed to pull double duty: protect your ATV and anything it comes in contact with, while also enhancing the look of your ATV.
- Made tough and designed to deliver a rugged appearance, together they offer front, rear and full side protection for farmer, rancher and forestry applications.
- Requires Body Side Protector Extensions (715003460) for installation on MAX models.
- This kit includes:
  - Rancher Front Bumper (715003461).
  - Rancher Rear Bumper (715003462).
  - Body Side Protector (715003459).
- Not compliant with T-category models

<b>Rancher Front Bumper</b>	G2, G2L (except X mr models)	715003461	1 753zł
-----------------------------	------------------------------	-----------	---------



- The low front end protection and plates allow you to use your ATV within cattle herds and guard the safety of both the vehicle and the animals.
- The flat front portion facilitates gently prodding cattle or pushing light objects, e.g. closing a fence.
- The full frontage coverage extends to provide an extra layer of defense to your headlights and radiator.
- Inside and outside anti-corrosion coating with durable powder coat finish.
- Not compatible with track systems, plows and front hitch.
- Not compliant with T-category models

<b>Rancher Rear Bumper</b>	G2, G2L (except 6x6 models)	715003462	1 489zł
----------------------------	-----------------------------	-----------	---------



- Ideal for using your ATV within cattle herds and guarding the safety of both the vehicle and the animals.
- Coverage extends to provide an extra layer of defense to your tail lights.
- Inside and outside anti-corrosion coating with durable powder coat finish.
- Not compatible with track systems.
- Not compliant with T-category models.

<b>Renegade Extreme Front Bumper</b>	G2S 2022 and prior (except X mr models)	715002469	1 390zł
--------------------------------------	---	-----------	---------



- Enhanced vehicle front protection.
- Required as a mounting point for Radiator Relocator (715008898).

## Guards

<b>Body Side Protector</b>	G2 2012 to 2018 with stock XT Bumper, G2 2012 & up with Rancher Bumper, G2L with Rancher Bumper, (except X mr and 6X6 models)	715003459	1 913zł
	G2 2019 & up with XT Bumpers, (except X mr and 6X6 models)	715004940*	1 968zł
	G2L with XT Bumpers, (except X mr and 6X6 models)	715003614	2 054zł



- The heavy-duty fender guard designed to pull double duty, protecting your ATV and also enhancing the look of your ATV.
- Made tough and designed to deliver a rugged appearance, this fender guard offers full side protection for farmer, rancher and forestry applications.
- Built of durably bold 1.25" (3 cm) diameter steel-tube construction, with inside and outside anti-corrosion coating with durable powder coat finish.
- Not compatible with Self Clearing Footwell.
- XT Front and Rear Bumpers or Rancher Front and Rear Bumpers are required for installation.
- Requires Body Side Protector Extensions (715003460) for installation on MAX models.

\*Not compatible with Front and Rear Rancher Bumpers.

<b>Body Side Protector Extensions</b> (Not illustrated)	G2, G2L (MAX models only)	715003460	382zł
--	---------------------------	-----------	-------







- This specially designed extension for the Body Side Protector is made specifically to fit and seamlessly integrate into the look of Outlander MAX models.









<b>Mud Flaps</b>	G2 (with stock fender flares)	<b>715007089</b>	<b>301 zł</b>
	<ul style="list-style-type: none"> <li>Keeps mud, snow and debris out of cargo area and protects trailer and vehicles behind you.</li> <li>Adds aesthetic appearance to your vehicle.</li> <li>Requires stock fender flare.</li> <li>Sold in pairs.</li> </ul>		
	G2 2012-2018 (except with 30" tires) (except 6x6 models)	<b>715001764*</b>	<b>757 zł</b>
	G2 2019 & up (with 30" tires) (except 6x6 models)	<b>715004250**</b>	<b>757 zł</b>
	G2L	<b>715001909***</b>	<b>757 zł</b>
<b>Fender Flares</b>	G2L European vehicles only 2015 & up	<b>715004487</b>	<b>818 zł</b>
	<ul style="list-style-type: none"> <li>Kit designed to deliver extra protection from dirt and debris, therefore a must if you enjoy riding in the mud.</li> <li>Made of injected plastic that hugs your vehicle fenders perfectly.</li> <li>Gives vehicle added flair for that rugged cool look.</li> <li>Includes front and rear extensions and all mounting hardware.</li> </ul> <p><i>*Comes stock on G2 models 2019 &amp; up (except X mr models).</i> <i>**Standard on G2 X mr 1000R.</i> <i>***Not compatible with European vehicles.</i></p>		
	G2 (except 6x6 models)	<b>715005111*</b>	<b>1 273 zł</b>
<b>Fender Flare Extensions</b>	G2L	<b>715003615**</b>	<b>1 273 zł</b>
	<ul style="list-style-type: none"> <li>Block terrain debris from kicking up onto you as you ride or damaging your vehicle thanks to these extra-large Fender Flare Extensions, which also include mud flaps for added protection from mud/snow, especially when riding with track kits.</li> <li>Made of High Molecular Weight Polyethylene (HMWPE) for advanced abrasion resistance.</li> <li>Include front and rear extensions.</li> </ul> <p><i>*Must be used with Fender Flare for G2 (715001764).</i> <i>**Must be used with Fender Flare for G2L (715001909).</i></p>		
	G2S (except X mr models)	<b>705012695</b>	<b>1 193 zł</b>
<b>Fender Flares</b>			
	<ul style="list-style-type: none"> <li>Integrated extended Fender Flares for sporty look and full body protection from dirt and water.</li> <li>Include front and rear extensions and all mounting hardware.</li> </ul>		
	G2 (6x6 models only)	<b>715002030</b>	<b>2 669 zł</b>
<b>Flatbed Protection Tubes</b>			
	<ul style="list-style-type: none"> <li>Bolt-on bumpers for the sides of the 6x6 flatbed.</li> <li>Protect the exterior plastic components of the flatbed from rocks, trees and other obstacles when traversing enclosed areas or loading cargo onto the bed.</li> </ul>		
	G2L (6x6 models only)	<b>715005266</b>	<b>1 833 zł</b>
<b>Flatbed Protection Tubes</b>			
	<ul style="list-style-type: none"> <li>Bolt-on bumpers for the sides of the 6x6 flatbed.</li> <li>Protect the exterior plastic components of the flatbed from rocks, trees and other obstacles when traversing enclosed areas or loading cargo onto the bed.</li> </ul>		



# LIGHTS & ELECTRICAL

<b>Integrated Heated Grips &amp; Thumb Throttle Combo</b>	G2, G2L, G2S (2021 & up)	<b>715005072</b> <b>1 667 zł</b>
	<ul style="list-style-type: none"> <li>Heat levels for grips and thumb displayed on vehicle screen.</li> <li>Ergonomic button integrated on LH grip.</li> <li>Single button for both grips and thumb heat selection.</li> <li>Five temperature settings for the thumb and grips.</li> <li>Adjustable heat ratio between grip and thumb warmer.</li> </ul>	<ul style="list-style-type: none"> <li>Hold button to reach maximum heat quickly.</li> <li>Remembers your last heat setting.</li> <li>IP67-rated waterproof sealing keeps the elements out.</li> <li>ECE compliant.</li> <li>Plug-and-play installation.</li> <li>Clamp-on grips, no glue required.</li> </ul>
<b>Heated Grips &amp; Thumb Throttle Combo</b>	<p>G2, G2L, G2S (except 2020 &amp; up models equipped with 850 engine and 2019 &amp; up models with 1000R engine, T Category models)</p> <p>G2, G2L, G2S (2020 &amp; up models equipped with 850 engine and 2019 &amp; up models with 1000R engine, T Category models)</p>	<p><b>715003250</b> Not compatible with Intelligent Throttle Control (ITC)</p> <p><b>715008739*</b> Compatible with Intelligent Throttle Control (ITC)</p> <p><b>1 562 zł</b></p>
	<ul style="list-style-type: none"> <li>LED dimmer facilitates reading temperature settings.</li> <li>4 temperature settings with individual controls for thumb and grips.</li> <li>Returns to previous heat setting.</li> </ul> <p><i>*Relocation bracket (715007619) required for installation on T-category models &amp; G2L XU (INTL model)</i></p>	<ul style="list-style-type: none"> <li>One-touch shutdown.</li> <li>Wiring Cable is required for installation on G2L models only.</li> </ul> <p><b>91 zł</b></p>
<b>Wiring Cable</b> <i>(Not illustrated)</i>	G2L	<b>710004567</b> <b>61 zł</b>
<ul style="list-style-type: none"> <li>Required for installation of Heated Hand Grips &amp; Throttle Combo.</li> </ul>		
<b>Heated Visor Outlet</b>	G2, G2L	<b>715001246</b> <b>317 zł</b>
	<ul style="list-style-type: none"> <li>Strategically positioned on vehicle to maintain your agility.</li> <li>Optional visor outlet that delivers fog-free riding.</li> <li>Quick and easy installation.</li> <li>Sold individually.</li> <li>Heated Visor not included.</li> </ul>	
<b>Heated Passenger Grips &amp; Visor Outlet</b>	G2, G2L (MAX models only)	<b>715008794</b> <b>1 322 zł</b>
	<ul style="list-style-type: none"> <li>Replace your stock passenger handles.</li> <li>Dual temperature switch integrated into seat arm for 3-zone heated handles and grips.</li> <li>Heated visor outlet integrated into seat arm.</li> </ul>	
<b>USB Power Outlet Kit</b>	G2, G2L, G2S	<b>219400510</b> <b>206 zł</b>
	<ul style="list-style-type: none"> <li>Recharges your electronic devices while riding (smartphone, MP3, heating gear, etc.).</li> <li>Dual port USB connectors.</li> <li>The power outlet is not capable of recharging all device types while riding.</li> </ul>	
<b>Seat Heater</b>	G2, G2L	<b>715007211</b> <b>751 zł</b>
	<ul style="list-style-type: none"> <li>25 W seat heater delivers chill-free riding comfort.</li> <li>One temperature only.</li> <li>Heated pad and electrical harness only.</li> <li>Heavy Duty Seat Cover (715007212) is required for the installation.</li> </ul>	
<b>Engine heater</b>	<b>605154278</b> <b>1 244 zł</b>	<b>715002043</b> <b>1 286 zł</b>
<ul style="list-style-type: none"> <li>Outlander 500 / 570 / 650 / 800 (G1/G2)</li> <li>Outlander 1000 (G2)</li> </ul>		

<b>Electronic Device Holder</b>	G2, G2L (except 6x6 & X mr models)	<b>715004919</b> <b>751 zł</b>
	<ul style="list-style-type: none"> <li>Robust injected-polypropylene construction allows for the right fit and easy installation.</li> <li>Adjustable unit safely holds smartphones or small tablets with a length or width measuring between 2.9" (7.5 cm) and 5.1" (13.0 cm) with or without protective case.</li> <li>Integrated storage (0.6 gal / 2.1 L).</li> </ul>	<ul style="list-style-type: none"> <li>Guiding wire grooves to pass charging cable through the lid.</li> <li>Possibility of relocating 12V power outlet or installing USB outlet in storage compartment (USB power outlet sold separately).</li> <li>Not compatible with windshields or Snorkel Kit.</li> </ul>
<b>3.5" (9 cm) LED Lights (2 X 14W) LED Driving Lights</b>	G2, G2L (except X mr models)	<b>715003666</b> <b>1 215 zł</b>
	<ul style="list-style-type: none"> <li>14W LED lights producing 1,260 lumens each.</li> <li>Equipped with 6 high power LEDs in a heavy-duty die cast aluminum housing.</li> <li>Features 2 attachment points — if one attachment point fails due to a collision, rotate to the next channel point and re-mount the light.</li> </ul>	<ul style="list-style-type: none"> <li>Sold in pairs.</li> <li>EC compliant.</li> <li>Spot lens for a narrow and long light beam spread, ideal when driving at higher speeds.</li> <li>Expedition Front Bumper (715007233) and Light Power Cable (715007275) required for installation.</li> </ul>
<b>3.5" (9 cm) LED Lights (2 X 14W) LED Flood Lights</b>	G2, G2L (except X mr models)	<b>715003665</b> <b>2 143 zł</b>
	<ul style="list-style-type: none"> <li>14W LED lights producing 1,260 lumens each.</li> <li>Equipped with 6 high power LEDs in a heavy-duty die cast aluminum housing.</li> <li>Features 2 attachment points — if one attachment point fails due to a collision, rotate to the next channel point and re-mount the light.</li> </ul>	<ul style="list-style-type: none"> <li>Sold in pairs.</li> <li>EC compliant.</li> <li>Flood lens for a wide light beam spread, ideal for working applications like plowing or for cornering, dusty or foggy riding conditions.</li> <li>Expedition Front Bumper (715007233) and Light Power Cable (715007275) required for installation.</li> </ul>
<b>4" (10 cm) Round LED Lights (2 x 25 W)</b>	G2, G2L (except X mr models)	<b>715002935</b> <b>1 754 zł</b>
	<ul style="list-style-type: none"> <li>25 W LED spotlights.</li> <li>1,800 lumens.</li> <li>Rugged and waterproof.</li> <li>Includes basic wiring and switch.</li> <li>Can-Am branded grill.</li> </ul>	<ul style="list-style-type: none"> <li>Sold in pairs.</li> <li>Not EC compliant.</li> <li>Expedition Front Bumper (715007233) and Light Power Cable (715007275) required for installation.</li> </ul>
<b>10" (25 cm) Double Stacked LED Light Bar (60 Watts)</b>	G2, G2L (except X mr models)	<b>715002933</b> <b>615 zł</b>
	<ul style="list-style-type: none"> <li>Equipped with 12 5W Cree LEDs.</li> <li>5,400 lumens.</li> <li>Rugged and waterproof.</li> <li>Packs a big punch for its size.</li> </ul>	<ul style="list-style-type: none"> <li>EC compliant.</li> <li>Expedition Front Bumper (715007233) and Light Power Cable (715007275) required for installation.</li> </ul>
<b>Light Power Cable</b> <i>(Not illustrated)</i>	G2, G2L	<b>715007275</b> <b>2 719 zł</b>
<ul style="list-style-type: none"> <li>Required for installation of the 10" (25 cm) LED Light Bar, the 3.5" (9 cm) and 4" (10 cm) LED Lights.</li> </ul>		
<b>Bluetooth Handlebar Soundbar by Mtx</b>	G2, G2L, G2S	<b>219400840</b>
	<ul style="list-style-type: none"> <li>Bluetooth speaker with the unbeatable convenience of fingertip control.</li> <li>Rugged IP66-rated weather-resistant speaker designed for outdoor use.</li> <li>Driven by 150 watts of quality audio power.</li> <li>Seamless integration and operation from Bluetooth enabled devices.</li> </ul>	<ul style="list-style-type: none"> <li>Includes input, ground and ignition wires, plus auxiliary port and 3.5" (8.89 cm) connector cable.</li> <li>Not compatible with XT Handlebar Protector Kit.</li> <li>EC compliant.</li> </ul> <p><i>Note: We recommend you use 320 Kbps MP3 - 192-256 Kbps AAC or AIFF, WAV formats to match the potential of the speaker. More compressed formats will probably have degraded sound quality.</i></p>
<b>Multi Position Light Mount Kit</b>	G2, G2L, G2S	<b>715004274</b> <b>541 zł</b>
	<ul style="list-style-type: none"> <li>Multi-position plastic clamps that fit on various tubing sizes: 0.75" to 1.5" (19 mm to 38 mm).</li> <li>Required for the installation of the 2" (5 cm) Square LED Lights (2 x 10W).</li> <li>Kit includes tube clamp mounts and power cables.</li> </ul>	

<b>Baja Designs High Beam Kit</b>	G2 (2022 and prior)	715004284 <b>3 843 zł</b>
	<ul style="list-style-type: none"> <li>Thanks to their direct bolt-on and plug-and-play installation right into the original high beam location, upgrading from your stock high beam lights to these powerful Baja Designs Squadron Pro LED Lights becomes child's play.</li> <li>Each spot is equipped with 4 Cree LEDs producing 4,900 lumens at 40 watts.</li> <li>Driving/Combo light pattern for smooth blend of light for both near field applications and distance.</li> <li>Not EC compliant.</li> </ul>	
<b>2" (5 cm) Square LED Lights (2 X 10 Watts)</b>	G2, G2L, G2S	715004293 <b>992 zł</b>
	<ul style="list-style-type: none"> <li>2 x 900 lumens 10W LED Cree light kit.</li> <li>Long-range illumination up to 350' (107 m), drawing less than 1 amp per light.</li> <li>Multi-Position Light Mount Kit is required for installation.</li> <li>Not EC compliant.</li> </ul>	
<b>RAM<sup>+</sup> LED Spotlight</b>	G2, G2L, G2S	710005423 <b>730 zł</b>
	<ul style="list-style-type: none"> <li>540 lumens LED light (9W) heavy-duty spotlight standard-equipped with 1" (2.5 cm) diameter rubber-coated double ball and socket system.</li> <li>Not EC compliant.</li> </ul>	
<b>Center Console Day Light</b>	G2S (except X mr)	715000691 <b>345 zł</b>
	<ul style="list-style-type: none"> <li>Mountable on top end of center console.</li> <li>Enhances look of vehicle.</li> </ul>	
<b>Battery Charger/Maintainer</b>	715005061	
	<ul style="list-style-type: none"> <li>Keeps stored lead-acid batteries charged.</li> <li>Charges and maintains small batteries.</li> <li>Microprocessor controlled multi-stage charging for added precision, safety and battery life.</li> <li>Automatically detects 6- or 12-volt batteries.</li> <li>Reverse hook-up protection helps protect battery and charger from damage.</li> <li>Auto-voltage detection.</li> <li>Press the display button to show the charge progress.</li> <li>Content: 3 amp battery charger, clamp adapter, DC adapter, 24" (61 cm) fused ring leads harness with weather cap, owner's manual.</li> <li>Not EC compliant.</li> <li>US plug (110V).</li> <li>Not available in Europe.</li> </ul>	
<b>Jump Starter</b>	715005062	
	<ul style="list-style-type: none"> <li>IPX3 water-resistant and enclosed output ports.</li> <li>4 LED battery indicators for easy read on battery charge level.</li> <li>Compact design, will conveniently fit in your backpack, glove box or any other storage compartment.</li> <li>2.4A + 1A/5V USB ports for fast charging of all USB devices.</li> <li>Smart cable provides protection against reverse polarity, short circuit, low voltage, high temperature and reverse charging.</li> <li>Built-in LED light (3 modes).</li> <li>Content: 300CA jump starter, SA858 smart cable clamp, MC-USB to USB charging cable, travel bag, user manual.</li> <li>Not EC compliant.</li> <li>Not available in Europe.</li> </ul>	
<b>Quick Connect Battery Cable</b>	715005408	
	<ul style="list-style-type: none"> <li>Quickly and easily connect and charge different items with your charger.</li> <li>Included in the Battery Charger/Maintainer (715005061).</li> <li>Sold individually.</li> <li>Not available in Europe.</li> </ul>	
<b>C-TEK charger</b>	860200997	
	<ul style="list-style-type: none"> <li>C-TEK, the manufacturer of the smartest battery chargers in the world, has produced a BRP specific charger for all BRP products.</li> <li>Charger is built to meet the demanding arctic conditions.</li> <li>Ask your dealer for more information.</li> </ul>	

**Quick Connect Cable with Battery Indicator**

715006055

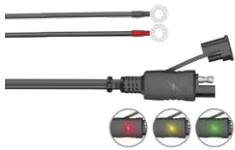

- Quickly and easily connect and charge different batteries with your charger.
- 3-color LED indicator provides constant battery health indication.
- Sold individually.
- Not available in Europe.

**GPS RAM Mount for Handlebar**

G2, G2L, G2S

715001985  
While supplies last



- Convenient bracket for installing the Garmin Montana GPS (not included) onto your unit's handlebar.

**Digitally Encoded Security System (D.E.S.S.)  
Green Key**

G2, G2S (2018 & up)

710005232

289 zł



- Anti-theft technology, Digitally Encoded Security System (D.E.S.S.) key snaps easily on the vehicle and provides riders easy and quick starts every time.
- The key communicates with the vehicle wirelessly so the vehicle starts only when the key code matches the vehicle, for ultimate peace of mind.
- The Programmable D.E.S.S. Key can also be programmed to 3 modes:
  - Work mode: Limits vehicle speed to 40 kph (25 mph) but does not limit engine torque.
  - Normal mode: Limits vehicle speed to 70 kph (44 mph) and 50% torque reduction.
  - Performance mode: No restrictions.

# WINCHES

## Can-Am HD Winches

### Can-Am HD 2500 Winch

G2, G2L

**715006414 1 550 zł**



- Heavy-duty four-way roller fairlead.
- Ergonomic clutch handle.
- Rugged all-steel gears and bushings provide more torque and longer life.
- Automatic 100% load-holding brake.
- Sealed solenoid for all-weather protection.
- Wired Remote Control sold separately.
- Plug-and-play wiring and attachment brackets.
- Weather-sealed handlebar-mounted switch.
- Pulling strength capability of 2,500 lb (1,134 kg).
- 50 ft. of 3/8" (15.2 m of 4.8 mm) wire steel cable.
- EC-compliant.

### Can-Am HD 3500 Winch

G2, G2L

**715006415 1 733 zł**



- Heavy-duty four-way roller fairlead.
- Ergonomic clutch handle.
- Rugged all-steel gears and bushings provide more torque and longer life.
- Automatic 100% load-holding brake.
- Sealed solenoid for all-weather protection.
- Wired Remote Control sold separately.
- Plug-and-play wiring and attachment brackets.
- Weather-sealed handlebar-mounted switch.
- Pulling strength capability of 3,500 lb (1,588 kg).
- 50 ft. of 3/8" (15.2 m of 4.8 mm) wire steel cable.
- EC-compliant.

## WARN<sup>†</sup> VRX Winches

### WARN VRX 25 Winch

G2, G2L, G2S

**715006107 2 546 zł**



- Extreme IP68-rated waterproof sealing keeps the elements out.
- Durable all-metal construction.
- Black powder-coated finish and stainless-steel fasteners for corrosion resistance.
- Robust new clutch design based on 70+ years of WARN 4WD hub lock know-how.
- Handlebar-mounted rocker control.
- Load-holding brake for great control.
- Smooth and reliable all-metal three-stage planetary gear train.
- Limited lifetime warranty (mechanical), 3-year warranty (electrical).
- Pulling strength capability of 2,500 lb (1,134 kg).
- 50 ft. of 3/8" (15 m of 4.8 mm) wire steel cable.
- Roller fairlead.
- Wire harness (715002453) required for installation.
- Winch mounting plate is required for G2S (STD & X xc 2022 & prior only).
- EC-compliant.

### WARN VRX 35 Winch

G2, G2L, G2S

**715006108 2 735 zł**



- Extreme IP68-rated waterproof sealing keeps the elements out.
- Durable all-metal construction.
- Black powder-coated finish and stainless-steel fasteners for corrosion resistance.
- Robust new clutch design based on 70+ years of WARN 4WD hub lock know-how.
- Handlebar-mounted rocker control.
- Load-holding brake for great control.
- Smooth and reliable all-metal three-stage planetary gear train.
- Limited lifetime warranty (mechanical), 3-year warranty (electrical).
- Pulling strength capability of 3,500 lb (1,361 kg).
- 50 ft. of 7/32" (15 m of 5.5 mm) wire steel cable.
- Roller fairlead.
- Wire harness (715002453) required for installation.
- Winch mounting plate is required for G2S (STD & X xc 2022 & prior only).
- EC-compliant.

### WARN VRX 35-S Winch

G2, G2L, G2S

**715006109 3 327 zł**



- Extreme IP68-rated waterproof sealing keeps the elements out.
- Durable all-metal construction.
- Black powder-coated finish and stainless-steel fasteners for corrosion resistance.
- Robust new clutch design based on 70+ years of WARN 4WD hub lock know-how.
- Handlebar-mounted rocker control.
- Load-holding brake for great control.
- Smooth and reliable all-metal three-stage planetary gear train.
- Limited lifetime warranty (mechanical), 3-year warranty (electrical).
- Pulling strength capability of 3,500 lb (1,361 kg).
- 50 ft. of 3/8" (15 m of 4.8 mm) synthetic rope.
- Cast aluminum fairlead.
- Wire harness (715002453) required for installation.
- Winch mounting plate is required for G2S (STD & X xc 2022 & prior only).
- EC-compliant.

### Rear winch kit

G2 (except 6x6 models)

**715007100 3 199 zł**

G2 (6x6 models only)

**715006503 2 718 zł**

G2L (6x6 models only)

**715007099 2 353 zł**



- The remote-controlled rear winch is a godsend when you want to pull yourself out of a tough spot or move heavy loads.
- Includes a fully-sealed Warn winch and all wiring and hardware needed for an easy and quick installation.
- Pulling strength capability of 3,000 lb (1,361 kg).
- 50 ft. of 7/32" (15.2 m of 5.5 mm) wire steel cable.

## Winches Accessories

<b>Wireless Remote Control</b>	WARN Winches	<b>715002542</b> <b>1 080 zł</b>						
	<ul style="list-style-type: none"> <li>The system is quick and easy to install, thanks to a wiring harness with an integrated antenna and all necessary mounting hardware.</li> <li>The system allows you to operate your winch from anywhere within a 50' (15.2 m) radius, increasing your recovery options.</li> <li>All components are weatherproof.</li> </ul>							
<b>Wired Remote Control</b>	<table border="1"> <tbody> <tr> <td>WARN Winches</td> <td><b>715006378</b> <b>468 zł</b></td> </tr> <tr> <td>Can-Am HD Winches (715006414 &amp; 715006415)</td> <td><b>715006555</b> <b>155 zł</b></td> </tr> <tr> <td>Can-Am HD Winches (715008140 &amp; 715008141)</td> <td><b>715008121</b> <b>159 zł</b></td> </tr> </tbody> </table>	WARN Winches	<b>715006378</b> <b>468 zł</b>	Can-Am HD Winches (715006414 & 715006415)	<b>715006555</b> <b>155 zł</b>	Can-Am HD Winches (715008140 & 715008141)	<b>715008121</b> <b>159 zł</b>	
WARN Winches	<b>715006378</b> <b>468 zł</b>							
Can-Am HD Winches (715006414 & 715006415)	<b>715006555</b> <b>155 zł</b>							
Can-Am HD Winches (715008140 & 715008141)	<b>715008121</b> <b>159 zł</b>							
	<ul style="list-style-type: none"> <li>This kit allows winch owners to add the hand-held remote to their winch.</li> <li>This kit allows winch owners to add the handheld remote to vehicles with a stock winch.</li> <li>Works in conjunction with the mini-rocker switch.</li> </ul>	<ul style="list-style-type: none"> <li>Wired Remote &amp; Remote Socket included.</li> <li>EC-compliant.</li> </ul>						
<b>Winch Accessories Kit</b>	<b>715002409</b> <b>732 zł</b>							
	<ul style="list-style-type: none"> <li>Get the most out of your winch.</li> <li>Double your pulling power, change your pulling direction and keep your winch in proper working order.</li> <li>Includes tree straps, snatch block, shackle and winching gloves.</li> </ul>							
<b>WARN Hawse Fairlead</b>	WARN Winches	<b>715007698</b> <b>388 zł</b>						
	<ul style="list-style-type: none"> <li>Double powder-coated construction.</li> <li>Required to use the Synthetic Winch.</li> <li>Cable (715004254) on WARN winches.</li> <li>To be used with synthetic winch cables only.</li> </ul>							
<b>Roller Fairlead</b>	<table border="1"> <tbody> <tr> <td>WARN Winches</td> <td><b>715007699</b> <b>388 zł</b></td> </tr> <tr> <td>Can-Am HD Winch</td> <td><b>710007459</b> <b>189 zł</b></td> </tr> </tbody> </table>	WARN Winches	<b>715007699</b> <b>388 zł</b>	Can-Am HD Winch	<b>710007459</b> <b>189 zł</b>			
WARN Winches	<b>715007699</b> <b>388 zł</b>							
Can-Am HD Winch	<b>710007459</b> <b>189 zł</b>							
	<ul style="list-style-type: none"> <li>Features top, bottom and side rollers for less cable wear and smoother operation from any direction for easier winching.</li> </ul>							
<b>Hook with Safety Latch &amp; Strap Kit</b>	Can-Am HD Winches	<b>705014949</b> <b>111 zł</b>						
	<ul style="list-style-type: none"> <li>Heavy-duty winch-rope hook with stainless steel snap.</li> <li>Includes a nylon safety strap.</li> </ul>							
<b>Replacement Wire Rope – Can-Am HD</b>	<table border="1"> <tbody> <tr> <td><b>705014983</b> <b>103 zł</b></td> </tr> <tr> <td><b>705014984</b> <b>198 zł</b></td> </tr> </tbody> </table>	<b>705014983</b> <b>103 zł</b>	<b>705014984</b> <b>198 zł</b>					
<b>705014983</b> <b>103 zł</b>								
<b>705014984</b> <b>198 zł</b>								
	<ul style="list-style-type: none"> <li>Play it safe, always carry a replacement wire rope.</li> <li>2,500 lb (1,134 kg) pulling strength with 50 ft of 3/16" (15.2 m of 4.8 mm) wire rope for 705014983.</li> <li>3,500 lb (1,588 kg) pulling strength with 50 ft of 7/32" (15.2 m of 5.5 mm) wire rope for 705014984.</li> </ul>							

<b>Replacement Wire Rope – ATV WARN Winches</b>	715006256	<b>394 zł</b>
---	-----------	---------------



- Play it safe, always carry a replacement wire rope.
- 3,500 lb (1,588 kg) pulling strength.
- 50 ft. of 7/32" (15.2 m of 5.5 mm) aircraft grade steel wire.

<b>Synthetic Winch Cable</b>	ATV WARN Winches	715004254	<b>738 zł</b>
------------------------------	------------------	-----------	---------------



- Easier to manipulate than steel cable.
- Replaces the original cable on any factory installed WARN winch or sold as an accessory by BRP.
- Kit includes synthetic rope and rock guard sleeve.
- Always use with the new Hawse Fairlead (715007698).
- 50 ft. (15.2 m) of 3/16" (15.2 m of 4.8 mm) synthetic rope.
- 3,500 lb (1,588 kg) pulling strength.

<b>Winch Mounting Plate</b>	G2S	715000927	<b>664 zł</b>
-----------------------------	-----	-----------	---------------



- Adds functionality to your Renegade.
- Fits Can-Am winches by WARN.

<b>Winch Wire Harness</b> (Not illustrated)	G2 2021 & up, G2S 2021 & up and G2L	715002453	<b>238 zł</b>
--	-------------------------------------	-----------	---------------

- Required plug-and-go wiring to install WARN winch only.
- Not required for Can-Am HD winches.

# HITCHES

## Hitches

<b>Rear Hitch</b>	G2, G2L (except 6x6 models), G2S	715001925	<b>282 zł</b>
-------------------	----------------------------------	-----------	---------------



- E-coat finish.
- Fixed hitch ball mounting bracket.
- Provides fixed mounting point for trailer ball to provide vehicle with towing capabilities.
- This hitch offers 1,300 lb (590 kg) of towing capacity.
- Hitch ball not included.

<b>Front and Rear Hitch Drawbar</b>	G2, G2L, G2S	715008350	<b>486 zł</b>
-------------------------------------	--------------	-----------	---------------



- Standard on 2" (5 cm) receiver hitch.
- It offers 1,650 lb (750 kg) of towing capacity.
- Hitch ball not included.
- Forged steel.

<b>Front coupling device</b>	T3	705205025	<b>247 zł</b>
------------------------------	----	-----------	---------------

- Required for T3 models.

<b>Multitrailer</b>	619590024	<b>1 070 zł</b>
---------------------	-----------	-----------------

- Bogie wheels updated to be more silent than before and now equipped with grease nipples.
- Product developed for heavy-duty use.
- 100% galvanized steel.
- Specifications: 12 mm polywood base, strong stand, movable attachment points (4 pc), tipping bed, removable sides and 4 pc timber holder.
- Underside of the bogie and frame designed to travel over stones and logs (no sharp edges).
- Bed length: 182 cm
- Bed width: 66 cm bottom / 95 cm top
- Bed height: 60 cm
- Weight: 200 kg with timber holders and sides

## Hitches Accessories

**Rear Receiver Hitch** | G2S 2012 with 800R or 1000 engines G2S 2013 & up, G2L & G2 | **715005186** **603 zł**



- E-coat finish.
- Does not affect ground clearance.
- Trailer ball not included.
- On 4X4 use, this hitch offers 1,500 lb (680 kg) of towing capacity.
- On 6x6 use, this hitch offers 1,654 lb (750 kg) of towing capacity.
- Compliant with European T regulations.
- Not compatible with G2L models with Rear Skid Plates.

**Front Receiver Hitch** | G2 | **715000921** **548 zł**



- Front receiver hitch for Outlander with or without a winch.
- This hitch offers 1,300 lb (590 kg) of towing capacity.
- Allows you to maneuver your trailer easily in tight, confined areas.
- Hitch bar sold separately.
- Not compatible with Extreme Front Bumper, Rancher Bumper and ProMount Plows.

**Rubber Receiver Plug** | **705204503** **65 zł**



- Rubber cap for 2" (5 cm) hitch receiver.

## PERFORMANCE

### Performance

**Renegade Snorkel Kit** | G2S (2020 & prior) | **715006000** **3 334 zł**  
 | G2S (2021 & up) | **715007083** **3 340 zł**



- Comprehensive kit.
- Extended air intakes and CVT exhaust.
- CVT outlet integrates into pod cover.
- Ideal for muddy conditions.

**Renegade Radiator Relocator Kit** | G2S 2023 & up | **715008898** **2 614 zł**  
 | G2S 2022 & prior | **715001929** **2 583 zł**



- Relocates radiator to top mount position.
- Prevents cooling performance loss in muddy conditions.
- Uses existing radiator.
- Includes support, hardware and hoses.
- Engineered for easy cooling system bleeding and maintenance.
- Radiator not included.
- Renegade Extreme Front Bumper (715002469) required for G2S 2022 and prior or X mr Front Bumper (715008198) required for 2023 and up for installation (except X mr).

**Mud Strap** | G2, G2L, G2S | **715003053** **246 zł**



- Convenient sturdy grab-handle.
- Lets drivers redistribute their weight for improved traction in demanding conditions.
- Not compatible with XT Handlebar Protector Kit (703100352).



<b>Radiator Protector</b>	G2, G2S (except G2S with 500 engine)	<b>715001744</b>	<b>382 zł</b>
	<ul style="list-style-type: none"> <li>▪ Metal shield that mounts over radiator face, providing protection from stones and branches.</li> </ul>		
<b>Outlander Snorkel Kit</b>	G2 2015 & up, G2L (except X mr & 6x6 models)	<b>715005999</b>	<b>2 399 zł</b>
	<ul style="list-style-type: none"> <li>▪ Comprehensive kit.</li> <li>▪ Extended air intakes and CVT exhaust.</li> <li>▪ CVT outlet integrates into pod cover.</li> <li>▪ Must be installed on a vehicle without XT Handlebar Protector Kit.</li> <li>▪ Ideal for muddy conditions.</li> <li>▪ Not compatible with windshields.</li> </ul>		
<b>Outlander Snorkel Kit</b>	G2 (X mr models only), G2L (X mr models only)	<b>715002518</b>	<b>584 zł</b>
	<ul style="list-style-type: none"> <li>▪ Comprehensive kit.</li> <li>▪ Extended air intakes and CVT exhaust.</li> <li>▪ CVT outlet integrates into pod cover.</li> <li>▪ Must be installed on a vehicle without XT Handlebar Protector Kit.</li> <li>▪ Ideal for muddy conditions.</li> <li>▪ Not compatible with windshields.</li> <li>▪ Raised horn only.</li> <li>▪ Provides higher intake.</li> <li>▪ For best fit and finish, appropriate gauge support is required.</li> </ul>		
<b>Outlander Radiator Relocator Kit</b>	G2, G2L (except 6x6 models)	<b>715001930</b>	<b>2 583 zł</b>
	<ul style="list-style-type: none"> <li>▪ Relocates radiator to top mount position.</li> <li>▪ Prevents cooling performance loss in muddy conditions.</li> <li>▪ Uses existing radiator.</li> <li>▪ Includes support, hardware and hoses.</li> <li>▪ Engineered for easy cooling system bleeding and maintenance.</li> <li>▪ Radiator not included.</li> </ul>		
<b>X mr Traction Plates</b>	G2 (MAX models only), G2L	<b>715001752</b>	<b>640 zł</b>
	<ul style="list-style-type: none"> <li>▪ Provide extra foot grip for driver when riding in extreme mud conditions.</li> <li>▪ Help driver maintain ideal riding position to maximize vehicle traction.</li> <li>▪ Made of aluminum.</li> <li>▪ Not meant for a passenger.</li> </ul>		
<b>Self-Clearing Footwells</b>	G2 2015 & up, G2L	<b>715004759</b>	<b>1 581 zł</b>
	<ul style="list-style-type: none"> <li>▪ Made from aluminum.</li> <li>▪ Replace original footwells.</li> <li>▪ Feature large evacuation ports to avoid mud and snow accumulation in footwells.</li> <li>▪ Aggressive design for improved traction.</li> <li>▪ Not compatible with Body Side Protectors.</li> <li>▪ Sold in pairs.</li> </ul>		
<b>Footpeg Kit</b>	G2, G2L	<b>715001131</b>	<b>286 zł</b>
	<ul style="list-style-type: none"> <li>▪ Provides maximum integrated grip and more stability during vigorous riding.</li> <li>▪ Kick-up end generates added grip during hard cornering.</li> <li>▪ Made of aluminum.</li> <li>▪ Sold in pairs.</li> </ul>		

**Foam Air Filter by Twinair†** | G2, G2S, G2L | **715001333** **353 zł**



- Maximizes performance by increasing air flow throughout RPM range.
- Maintenance-friendly, i.e., just wash, re-oil and re-use after riding in severely dusty/muddy environments.

<b>Heavy-Duty Springs</b>	G2 2012-2018 (Base model, DPS, XT, X mr with 650 engine only & Limited – except 6x6) G2S (Base model with 500 & 570 engines only)	<b>715003199</b> · Front	<b>812 zł</b>
	G2L (except Mossy Oak, PRO, 6x6 and X mr models)	<b>715007203</b> · Front	
	G2 2012-2018 (Base model, DPS, XT & X mr with 650 engine only – except 6x6) G2S (Base model with 500 & 570 engines only)	<b>715003200</b> · Rear	<b>812 zł</b>
	G2 2019 & up (Base, DPS & XT models, except 6x6)	<b>715005159</b> · Front & Rear	<b>1359 zł</b>



- Heavy-duty springs provide enhanced stiffness.
- Perfect for snow clearing and hauling heavy loads.
- Improves handling and helps prevent accidental overturns.
- Kit includes 4 springs.
- Standard on Outlander PRO and Mossy Oak models.

**Front Shock Covers** | G2, G2L, G2S | **715500301** **246 zł**



- Feature ventilation holes.
- Offer added protection in rough terrain and weather conditions.
- Sold in pairs.

<b>Front and Rear Heavy-Duty Shock kits</b>	G2L (4x4 and 6x6 models)	<b>715007841</b>	<b>7 110 zł</b>
	G2L (4x4 and 6x6 models)	<b>715008136</b>	<b>7 097 zł</b>

- Stiffer shocks than the standard ones, for Heavy-duty usage.
- Improved load capacity, ground clearance and comfort (front and rear).
- Sold in pairs.

**Extreme Heavy-Duty rear spring set** | **715001998** · Fitting into G2 **1 581 zł**

- E.g. for use with Forest Pro Log Trailer.

## Yoshimura

**Yoshimura Slip-On Exhaust – Outlander** | G2 (except 6x6 models) | **715005480**



- Made from 304-grade stainless steel.
- Better sounding, better looking and lighter than stock muffler.
- USDF/USDA approved spark arrester.
- Non-EPA compliant (for racing application only).
- Not EC compliant.
- Fuel injection system tuning not required.
- Not compatible with CARB & T Category models 2018 & up, NRMM & 650 Engine 2022 & up.
- Not available in Europe.

**Yoshimura Slip-On Exhaust – Renegade** | G2S 2012 & up (except 570 engine and X mr models) | **715005481**



- Made from 304-grade stainless steel.
- Better sounding, better looking and lighter than stock muffler.
- USDF/USDA approved spark arrester.
- Non-EPA compliant (for racing application only).
- Not EC compliant.
- Fuel injection system tuning not required.
- Not compatible with CARB & T Category models 2018 & up, NRMM & 650 Engine 2022 & up.
- Not available in Europe.

## Emergency Accessories

**Emergency Kit** | **715006102** **763 zł**



- Complete emergency kit provides all essential equipment and supplies to get out of most unfavorable situations powersport enthusiasts may find themselves in.
- Includes jumper cables, air compressor, tire-repair kit, first-aid kit, ratchet tie-down, duct tape, 3,300 lb (1,500 kg) tow strap, zip-ties and cloth rags.

# COVERS, DECALS & ADD-ONS

## Trailer Covers



G2 (except MAX models)	<b>715001737</b>	<b>1 187 zł</b>
G2 (MAX and X mr 1000R models only)	<b>715001736</b>	<b>1 433 zł</b>
G2L (except MAX models)	<b>715002026</b>	<b>1 187 zł</b>
G2L (MAX models only)	<b>715002025</b>	<b>1 452 zł</b>
G2S (except X mr models)	<b>715000683</b>	<b>1 064 zł</b>

<b>715001737</b>	<b>1 187 zł</b>
<b>715001736</b>	<b>1 433 zł</b>
<b>715002026</b>	<b>1 187 zł</b>
<b>715002025</b>	<b>1 452 zł</b>
<b>715000683</b>	<b>1 064 zł</b>

- Heavy-duty canvas made of UV-resistant solution-dyed polyester.
- Protect windshield and colored panels from abrasion.
- All high-abrasion areas are reinforced with a double canvas layer.
- Opening for fuel cap access.
- Weather-resistant trailable cover protects your vehicle during transportation.
- Quick and easy installation.
- Designed to perfectly fit your vehicle with or without Can-Am accessories.

## Storage Covers



G2, G2L, G2 X mr (except 1000), G2L X mr, G2S, G2S X mr	<b>715001720</b>	<b>1 206 zł</b>
G2, G2L (MAX and X mr 1000R models only)	<b>715001668</b>	<b>1 150 zł</b>
G2 (6x6 models only)	<b>715002492</b>	
G2, G2L (except MAX models)	<b>715005095</b> (Europe)	<b>2 426 zł</b>
G2 MAX, G2 X mr 1000, G2L MAX	<b>715001597</b> · Mossy Oak Break-Up Country Camo	<b>1 279 zł</b>
G2 MAX (6x6 models only)	<b>715001735</b> · Mossy Oak Break-Up Country Camo	<b>1 335 zł</b>
G2L (6x6 models only)	<b>715004488</b>	<b>1 661 zł</b>
G2L MAX (6x6 models only)	<b>715005261</b>	<b>1 478 zł</b>
	<b>715006024</b>	<b>1 304 zł</b>

<b>715001720</b>	<b>1 206 zł</b>
<b>715001668</b>	<b>1 150 zł</b>
<b>715002492</b>	
<b>715005095</b> (Europe)	<b>2 426 zł</b>
<b>715001597</b> · Mossy Oak Break-Up Country Camo	<b>1 279 zł</b>
<b>715001735</b> · Mossy Oak Break-Up Country Camo	<b>1 335 zł</b>
<b>715004488</b>	<b>1 661 zł</b>
<b>715005261</b>	<b>1 478 zł</b>
<b>715006024</b>	<b>1 304 zł</b>

- Weather-resistant storage covers.
- For vehicle storage only.
- UV-resistant solution-dyed polyester construction.
- Quick and easy installation.
- Designed to perfectly fit your vehicle with or without Can-Am accessories.

## Flag



- Make sure everyone knows what you're riding.
- Perfect for the dunes and new riders.
- 8-ft. (2.4 m) length.
- Includes flag mount (715000127).

**715000277** · Yellow **155 zł**

## Flag Mount (Not illustrated)

**715000127** **113 zł**

## Bolt-On<sup>+</sup> Retractable Ratcheting Tie-Downs

**295101072** **186 zł**







- Perfect for transporting your powersport vehicle or securing loads.
- Mounts easily: Bolts on any flat surface (e.g., truck bed or frame).
- 1" x 6' (2.5 cm x 1.8 m) tie-down strap with heavy-duty stitching that delivers a 500 lb (226 kg) working load strength and 1,500 lb (680 kg) break strength.
- Convenient retractable push button automatically slackens, spools and stores away strap, while the ratchet mechanism tightens the strap snugly to secure your vehicle or load into place.
- Rubber ratcheting handle provides firm grip, and the hook is vinyl coated to protect whatever surface it hooks into.
- Sold in pairs.

## Ratchet Tie-Downs

**715008309** · Black/Gray **107 zł**



- 400 lb (181 kg) safe working load.
- 1" x 10' (2.5 cm x 3 m) strap with Can-Am, Sea-Doo, and Ski-Doo logos.
- Deluxe ratchet with rubber handle.
- Coated S hooks.
- Pack of 2.

<b>Heavy-Duty Ratchet Tie-Down</b>		715008308 <b>230 zł</b>
 <ul style="list-style-type: none"> <li>▪ 1,000 lb (454 kg) safe working load.</li> <li>▪ 1.5" x 6' (38 mm x 1.8 m) strap with BRP brands.</li> <li>▪ Deluxe ratchet with rubber handle.</li> <li>▪ Black-coated clip hooks.</li> <li>▪ 12" (300 mm) webbing included.</li> <li>▪ Pack of two.</li> </ul>		
<b>Shifter Lock</b>	G2, G2L	715007337 <b>305 zł</b>
 <ul style="list-style-type: none"> <li>▪ Secure the vehicle's shifter by locking it in position.</li> <li>▪ Prevents the vehicle from going into neutral without the lock key.</li> </ul>		
<b>Lockable Gas Tank Cap</b>	G2, G2L, G2S	860200387 <b>234 zł</b> 619590085 (Scandinavia)
 <ul style="list-style-type: none"> <li>▪ Protects your fuel.</li> <li>▪ Meets EPA requirements.</li> </ul>		
<b>License Plate Bracket</b>	G2L G2S	715002498 <b>115 zł</b> 715001401 <b>123 zł</b>
 <ul style="list-style-type: none"> <li>▪ Provides specific area to install license plate.</li> <li>▪ Mounts to rear of vehicle.</li> </ul>		

# APACHE TRACK SYSTEMS

## Apache Track Systems

### Apache Backcountry Track System

G2 (except 6x6 models), G2S, G2L

715005247

36 575 zł



- Designed to deliver the best flotation level and deep-snow performance on the market.
- Contact patch is 23% bigger than the Apache 360 LT.
- Impressive added ground clearance of 7" (18 cm), keeps the vehicle out of deep snow.
- Aggressive track design with 2" (5 cm) lug height for maximum traction on snow.
- Apache Backcountry Mounting Kit and engine and air intake pre-filters are required.
- For winter use only.

### Idler Wheel Kit

Apache Backcountry Track System (rear tracks only)

860201230 · 141 mm

278 zł



- Reduces drag and rolling resistance.
- Includes 2 wheels, brackets and hardware.
- Add up to 2 kits per rear track.
- Can extend slider life in hardened snow conditions.

### Sliders with Vespel<sup>†</sup> Inserts

Apache Backcountry Track System

503194815

498 zł



- Use DuPont Vespel inserts for less friction.
- Longer life.
- Can be cut to desired length.
- 8 needed per vehicle.
- Sold individually.

### Rail Ice Scratchers

Apache Backcountry Track System

860201728

538 zł



- Provide additional lubrication in hard and icy conditions.
- Rail mounted, small, light.
- Design expands on coil concept to allow reversing without damage.
- Easily stored when not in use.

## Apache 360 & 360 LT

### Apache 360 Track System

G2 (except 6x6 models), G2L, G2S

715006323

29 470zł



- Multifunctional tracks perfect for any Can-Am ATV.
- Average ground clearance of 16" (41 cm).
- 1" (2.5 cm) lugs in the front and 1.25" (3.2 cm) in the back.
- Apache 360 & 360 LT Mounting Kit and engine and air intake pre-filters are required.

### Apache 360 LT Track System

G2, G2L, G2S

715005103

35 903 zł



- Multifunctional tracks designed to support heavy loads and to fit on most Can-Am Off-Road vehicles.
- Front wheel height adjustment provides enhanced attack angle and better performance over rough terrain when raised or increased contact patch for improved flotation when lowered.
- Average ground clearance increase of 4.5" (11.4 cm).
- 1" (2.5 cm) lugs in the front and 1.25" (3.2 cm) in the back.
- Reliable heavy-duty build.
- EC compliant.
- Contact patch is 7 to 9% bigger than the Apache 360's.
- Apache 360 and 360 LT Mounting Kit, Track DPS Module and Engine and air intake pre-filters are required.

## Apache 360 LT 6x6

### Apache 360 LT (6x6) Track System

G2, G2L (6x6 only)

715005104

42 155 zł



- Multifunctional tracks designed to support heavy loads and to fit on most Can-Am Off-Road vehicles.
- Front wheel height adjustment provides enhanced attack angle and better performance over rough terrain when raised or increased contact patch for improved flotation when lowered.
- Average ground clearance increase of 4.5" (11.4 cm).
- 1" (2.5 cm) lugs in the front and 1.25" (3.2 cm) in the back.
- Apache 360 LT Mounting Kit, Track DPS Module and Engine & Pre-Filter Kit are required.
- Reliable heavy-duty build.
- EC compliant.
- Exclusively for the Outlander 6x6.
- Recommended for use on snow only.

## Apache Accessories

### Apache Backcountry Mounting Kit

(Not illustrated)

G2 2018 & prior, G2S 2018 & prior, G2L

715004830

3 097 zł

G2 2019, G2S 2019

715004796

3 097 zł

- Required for installation of the Apache Backcountry Track System.
- DPS module and pre-filter are required and sold separately.

### Track DPS Module

(Not illustrated)

G2, G2L, G2S

715007338

464 zł

- An innovative DPS module that ensures speedometer accuracy and optimized steering assist, which make for perfect track control and riding ease.
- Required to install the Apache and Backcountry Track Systems.

### Apache 360 & 360 LT Mounting Kit

(Not illustrated)

G2 2018 & prior (except 6x6 models) G2S 2018 & prior, G2L

715007207

1 802 zł

G2 2019 & up (except 6x6 models), G2S 2019 & up

715007206

1 802 zł

G2 2018 & prior, G2L (6x6 models)

715004991

1 061 zł

G2 (6x6 models 2019 & up)

715005105

1 061 zł

- Required to install Apache 360 & 360 LT Track Systems.
- DPS module and pre-filter not included.

## Apache Track System Accessories

### Air Intake Pre-Filter

715003483

246 zł



- Adds extra protection to your engine in harsh riding conditions.
- Filter blocks particles larger than 0.007" (0.19 mm).
- Easy, tool-less installation.
- Necessary to maintain vehicle warranty when tracks are installed.
- Required to install the Apache and Backcountry Track Systems.
- Standard on Outlander 650, 650 X mr, 850, 1000, 1000R engines and G2L PRO.
- Not compatible with Snorkel Kits.

### Engine Air Intake Pre-Filter

G2, G2L, G2S

715004729

198 zł



- Adds extra protection to your engine in harsh riding conditions.
- Filter blocks particles larger than 0.005" (0.13 mm).
- Necessary to maintain vehicle warranty when tracks are installed.

## APACHE TRACK SYSTEMS FITTING GUIDE

### Apache Backcountry

Model Year / Model	Track	Track Mount	Track DPS Module	Prefilter without Snorkel	Prefilter with Snorkel
2015 & Up G2L	715005247	715004830	715007338	715004729 & 715003483 (standard on G2 models and G2L PRO model)	715004729
2018 & Prior G2, G2S					
2019 & Up G2, G2S		715004796			

### Apache 360 and Apache 360 LT

Model Year / Model	Track	Track Mount	Track DPS Module	Prefilter without Snorkel	Prefilter with Snorkel
2015 & Up G2L	715006323 (Apache 360) OR 715005103 (Apache 360 LT)	715007207	715007338	715004729 & 715003483 (standard on G2 models and G2L PRO model)	715004729
2018 & Prior G2, G2S					
2019 & Up G2, G2S		715007206			

### Apache 360 LT 6x6

Model Year / Model	Track	Track Mount	Track DPS Module	Prefilter without Snorkel	Prefilter with Snorkel
2018 & Prior G2 6x6	715005104	715004991	715007338	715004729 & 715003483 (standard on G2 models and G2L PRO model)	715004729
2019 & Up G2L 6x6					
2019 & Up G2 6x6		715005105			

# PROMOUNT PLOWS

## PROMOUNT PLOW KITS

### Reference Chart

	54" Black Steel	54" Yellow Steel	60" Black Steel	60" Yellow Steel	66" Black Steel	66" Yellow Steel	60" Flex2	66" Flex2
Plow Kit	715007753	715008178	715007754	715008179	715007755	715008180	715008181	715008182
Blade	715004472	715005316	715004202	715005317	715006337	715006338	715004203	715006265
Push Frame	715007752	715007752	715007752	715007752	715007752	715007752	715007752	715007752
Mounting Plate	715007751	715007751	715007751	715007751	715007751	715007751	715007751	715007751

### Steel Plows

#### Can-Am ProMount Steel Plow Kits 54" (137 cm) Blade

G2, G2L, G2S

■ 715007753 · Black  
■ 715008178 · Yellow



- These kits include:
  - Can-Am ProMount Steel Blade
  - Push Frame with Quick-Attach System
  - Mounting Plate

#### Can-Am ProMount Steel Plow Kits 60" (152 cm) Blade

G2, G2L, G2S

■ 715007754 · Black  
■ 715008179 · Yellow



- These kits include:
  - Can-Am ProMount Steel Blade
  - Push Frame with Quick-Attach System
  - Mounting Plate

#### Can-Am ProMount Steel Plow Kits 66" (168 cm) Blade

G2, G2L, G2S

■ 715007755 · Black  
■ 715008180 · Yellow



- These kits include:
  - Can-Am ProMount Steel Blade
  - Push Frame with Quick-Attach System
  - Mounting Plate

#### Can-Am ProMount Steel Blades 54" (137 cm) Blade

Fits ProMount Push Frame

■ 715004472 · Black  
■ 715005316 · Yellow

1 530 zł



- Blades available individually to create your own kit.
- Compatible with Can-Am ProMount Blade accessories to further enhance plow versatility (some plow accessories are not compatible with 54" (137 cm) plows).
- Not compatible with ProMount Drift Cutters, Blade Extensions and Edge Markers.
- Clears 50" (127 cm) when plow is fully angled.
- Blade height of 14.75" (37 cm).



**Can-Am ProMount Steel Blades  
60" (152 cm) Blade**

Fits ProMount Push Frame

■ 715004202 · Black **1 669 zł**  
 ■ 715005317 · Yellow



- Blades available individually to create your own kit.
- Compatible with Can-Am ProMount Blade accessories to further enhance plow versatility.
- Clears 54" (137 cm) when plow is fully angled.
- Blade height of 17" (43 cm).

**Can-Am ProMount Steel Blades  
66" (168 cm) Blade**

Fits ProMount Push Frame

■ 715006337 · Black **1 903 zł**  
 ■ 715006338 · Yellow **1 812 zł**



- Blades available individually to create your own kit.
- Compatible with Can-Am ProMount Blade accessories to further enhance plow versatility.
- Clears 60" (152 cm) when plow is fully angled.
- Blade height of 17" (43 cm).

**Can-Am ProMount Steel Blades  
72" (183 cm) Blade**

Fits ProMount Push Frame

■ 715004474 · Black **2 260 zł**  
 ■ 715006021 · Yellow



- Blades available individually to create your own kit.
- Compatible with Can-Am ProMount Blade accessories to further enhance plow versatility.
- Clears 66" (168 cm) when plow is fully angled.
- Blade height of 17" (43 cm).

**Can-Am ProMount Flex2 Plow Kit**

**Can-Am ProMount Flex2 – 60" (152 cm) Plow Kit**

G2, G2L, G2S

715008181



- These kits include:
  - Can-Am ProMount Flex2 Blade **2 090 zł**
  - Push Frame with Quick-Attach System **2 351 zł**
  - Mounting Plate **741 zł**

**NEW Can-Am ProMount Flex2 – 66" (168 cm) Plow Kit**

G2, G2L, G2S

■ 715008182 · Black



- This kit includes:
  - Can-Am ProMount Flex2 blade **2 780 zł**
  - Push Frame with Quick-Attach System **2 351 zł**
  - Mounting plate **741 zł**

## Angle Plows

### Can-Am ProMount Angle Blades 60" (152 cm) Steel Oneway State Blade

G2, G2L, G2S

715007261

1 978 zł



- Make the job easier with the right tools, clear long alleys and make the task easier by sending the snow further out of the way.
- Wing end of plow measures 25" (63 cm) high and tapers down to 17" (43 cm).
- One-way "winged" state plow designed to throw snow higher.
- Rubber flap (715007299) designed to keep snow away from the driver is offered as accessory (sold separately).
- Can-Am branded.

### Can-Am ProMount Angle Blades 66" (168 cm) Steel Oneway State Blade

G2, G2L, G2S

715007263

2 303 zł



- Make the job easier with the right tools, clear long alleys and make the task easier by sending the snow further out of the way.
- Wing end of plow measures 25" (63 cm) high and tapers down to 17" (43 cm).
- One-way "winged" state plow designed to throw snow higher.
- Rubber flap (715007299) designed to keep snow away from the driver is offered as accessory (sold separately).
- Can-Am branded.

### Can-Am ProMount Angle Blades 72" (183 cm) Steel Oneway State Blade

G2, G2L, G2S

715007264

2 543 zł



- Make the job easier with the right tools, clear long alleys and make the task easier by sending the snow further out of the way.
- Wing end of plow measures 25" (63 cm) high and tapers down to 17" (43 cm).
- One-way "winged" state plow designed to throw snow higher.
- Rubber flap (715007299) designed to keep snow away from the driver is offered as accessory (sold separately).
- Can-Am branded.

### ProMount One-Way State Blade Rubber Flap (Not illustrated)

715007299

571 zł

- Allows for more efficient snow projections in various snow conditions.

## Can-Am ProMount Flex2 Plows

### Can-Am ProMount Flex2 Blades – 60" (152 cm) Blade

Fits ProMount Push Frame

715004203

2 090 zł



- Plow blade made of UHMWPE, flexible and impact absorbing material prevents damaging your plow when accidental impacts occur.
- Replaceable wear blade.
- Large pin designed for easy blade rotation to eliminate snow buildup at pivot point.
- Blade design provides best snow roll-off at any angle.
- Compatible with Can-Am ProMount Blade accessories to further enhance plow versatility.
- Clears 54" (137 cm) when plow is fully angled.

### NEW Can-Am ProMount Flex2 66" (168 cm) Blade

Fits ProMount Push Frame

715006265

2 780 zł



- Plow blade made of UHMWPE, flexible and impact absorbing material prevents damaging your plow when accidental impact occurs.
- Replaceable wear blade.
- Large pin designed for easy blade rotation to eliminate snow buildup at pivot point.
- Blade design provides best snow roll-off at any angle.
- Clears 60" (152 cm) when plow is fully angled.
- Blade height of 17" (43 cm).
- Compatible with Can-Am ProMount Blade accessories to further enhance plow versatility."

### Can-Am ProMount Flex2 Blades – 72" (183 cm) Blade

Fits ProMount Push Frame

715004485

2 772 zł



- Plow blade made of UHMWPE, flexible and impact absorbing material prevents damaging your plow when accidental impacts occur.
- Replaceable wear blade.
- Large pin designed for easy blade rotation to eliminate snow buildup at pivot point.
- Blade design provides best snow roll-off at any angle.
- Compatible with Can-Am ProMount Blade accessories to further enhance plow versatility.
- Clears 66" (168 cm) when plow is fully angled.

## Can-Am ProMount Plow Accessories

### Can-Am ProMount Push Frame with Quick-Attach System

G2, G2L, G2S

715007752

2 351 zł



- Heavy-duty steel tubes designed to withstand the roughest use.
- Mid-mount carriage provides ultimate push strength and traction.
- Designed for maximum plow lift height.
- Features a self-aligning quick-attach system, an easy foot release pedal and an ergonomic handle for plow angle adjustment.
- Plow Roller Fairlead and Plow Limit Switch recommended to extend winch cable lifespan.
- Can-Am ProMount Mounting Plate required for installation.
- Blade swivels left or right, 5 positions.
- Large pin designed for easy blade rotation to eliminate dirt and snow buildup at pivot point.

### Can-Am ProMount Mounting Plate

G2, G2L, G2S

715007751

741 zł



- Required to install the Can-Am ProMount Push Frame with Quick-Attach System.
- Mounting plate precision-designed to stay on year round without compromising ground clearance.
- Fits on ATVs with or without Can-Am Skid Plates.
- Plow Roller Fairlead included.

### Can-Am ProMount Push Frame Extension

G2, G2L, G2S

715006257

821 zł



- 12" (30 cm) push frame extension.
- Required when plow is installed with Apache Track System.

### Can-Am ProMount Edge Markers

G2, G2L, G2S

715004206

218 zł



- Help locate the edges of your plow.
- Height: 24" (60 cm).
- Sold in pairs.
- Compatible with Can-Am ProMount Steel and Flex2 Blades with or without Blade Extensions (except for the Can-Am ProMount Steel 54" (137 cm) Blades).

### Can-Am ProMount Drift Cutters

G2, G2L, G2S

715006258

746 zł



- Help keep snow in the plow.
- Dimensions: 17" x 13" (43.2 cm x 33 cm).
- Sold in pairs.
- Compatible with Can-Am ProMount Steel and Flex2 Blades with or without Blade Extensions (except for the Can-Am ProMount Steel 54" (137 cm) Blades).

### Can-Am ProMount Curved Wear Blade

G2, G2L, G2S

544 zł

715007791 · 60" (152 cm)

715007792 · 66" (168 cm)



- Wear blade designed with a folded back bottom lip.
- The increased surface allows for less digging while plowing uneven surfaces.
- Ideal for snow covered gravel, grass, paver stone and other soft surfaces.

### Can-Am ProMount Plastic Wear Blade

G2, G2L, G2S

715004480 · 54" (137 cm) 448 zł

715004481 · 60" (152 cm) 448 zł

715004482 · 66" (168 cm) 448 zł

715004483 · 72" (183 cm) 746 zł



- To help prevent scratches on smooth driveways and markable surfaces.

**Can-Am ProMount Blade Extensions**

G2, G2L, G2S

■ 715004205 - Black  
 ■ 715005319 - Yellow



- Add 3" (8 cm) each side.
- Compatible with Can-Am ProMount Blades (except for Can-Am ProMount Steel 54" (137 cm) Blade).
- Longer Wear Blade can be installed to further extend the extra length already provided by the extensions.
- Compatible with Can-Am ProMount Steel and Flex2 Blades (except for the Can-Am ProMount Steel 54" (137 cm) Blades).

**Back Drag Blade**

ProMount Plows (60" and more)

715007794 1 327 zł



- ¼ thick steel swivel scraper.
- Lifts up when the vehicle is moving forward so as not to affect the scraping.
- Increased capacity to pull snow.
- More aggressive scraping in reverse mode.
- Lifts the blade off the ground so that it scrapes evenly.
- Adjustable in length for compatibility with 60", 66" and 72" blades.
- Compatible with ProMount blades (Flex and Steel).

**Plow Roller Fairlead**

G2, G2L, G2S

705009222 357 zł



- Larger diameter lower roller reduces wear on wire rope for plow application.
- Can be used with all ProMount plows.
- Included in plow mounting plate kit (715007751).

**Pulley Kit for Alpine Super-Duty Plow**

G2, G2L

715000279 314 zł



- Pulley kit to be used in conjunction with the winch when using a snow plow.
- Recommended to increase winch efficiency.
- To be used with the XT Front Bumper.

**Synthetic Winch Cable for Plowing**

715000540 224 zł



- Specially designed for plowing applications.
- 8' (2.4 m) section of durable, extra-strong synthetic rope.
- Stands up to repeated, sharp angle pulls used to lift heavy plow blades.
- Temporarily replace your winch rope for plow season to save wear and tear on wire rope.

**Plow Limit Switch**

(Not illustrated)

G2, G2L, G2S

715006259 635 zł

- For controlling the cable tension when over raising your plow system.
- Prevents winch, plow push frame and vehicle damage.

**Can-Am ProMount Plow Angling System**

G2, G2L, G2S

715007801 3 774 zł









- Converts your plow system into an easy-to-control unit from the driver's seat.
- Using one hand to control all plow motions will allow you to easily concentrate and manage your plowing tasks.
- Compatible with ProMount Blade.
- Push Frame (715007752) is required.
- Push Frame Extension (715006257) is required for installation with the Front Rancher Bumper.
- Winch and plow sold separately.

# TIRES & RIMS

## Tires

<b>Carlisle ACT Tire</b>	G2 (500-1000 XT models only)	<b>705401333</b> · Front <b>629 zł</b> <b>705401334</b> · (€) <b>705501769</b> · Rear <b>714 zł</b> <b>705501770</b> · (€)
	<ul style="list-style-type: none"> <li>• Front - 26" x 8" x 12".</li> <li>• Rear - 26" x 10" x 12".</li> </ul>	
<b>Carlisle ACT Tire</b>	G2 (400 XT models only)	<b>705400606</b> · Front <b>587 zł</b> <b>705400326</b> · (€) <b>705500598</b> · Rear (€) <b>608 zł</b>
	<ul style="list-style-type: none"> <li>• Front - 25" x 8" x 12".</li> <li>• Rear - 25" x 11" x 12".</li> </ul>	
<b>Carlisle ACT HD Tire</b>		<b>705402562</b> · Front <b>651 zł</b> <b>705502940</b> · Rear <b>714 zł</b>
	<ul style="list-style-type: none"> <li>• Front - 26" x 8" x 12".</li> <li>• Rear - 26" x 10" x 12".</li> </ul>	
<b>Carlisle Badlands A/R Tire</b>	G2 (500-1000 Base models only)	<b>705401331</b> · Front <b>693 zł</b> <b>705401332</b> · (€) <b>705501767</b> · Rear <b>736 zł</b> <b>705501768</b> · (€)
	<ul style="list-style-type: none"> <li>• Front - 26" x 8" x 12".</li> <li>• Rear - 26" x 10" x 12".</li> </ul>	
<b>Carlisle Trail Wolf Tire</b>	G2 (400 Base models only) G2L (450/570)	<b>705402890</b> · Front <b>869 zł</b> <b>705400607</b> · (€) <b>705503225</b> · Rear <b>821 zł</b> <b>705502165</b> · (€)
	<ul style="list-style-type: none"> <li>• Front - 25" x 8" x 12".</li> <li>• Rear - 25" x 11" x 12".</li> </ul>	
<b>ITP TerraCross Tire</b>	G2 XTP, G2 Limited	<b>705402973</b> · Front <b>693 zł</b> <b>705502858</b> · Rear <b>778 zł</b>
	<ul style="list-style-type: none"> <li>• This smooth-riding tire will command every bit of traction from the ground while still managing to float across loose snow, sand and mud.</li> <li>• Features extreme-duty construction for improved puncture protection and extra-tough rubber compound for increased tread life. The interlocking tread pattern and wide footprint make it one of the toughest and grippiest radials around.</li> <li>• Not EC compliant.</li> <li>• Front - 26" x 8" x 14".</li> <li>• Rear - 26" x 10" x 14".</li> </ul>	

<b>ITP Holeshoot ATR Tire</b>	G2S	<b>705400600</b> · Front <b>800 zł</b> <b>705400475</b> · C€ <b>705500926</b> · Rear <b>693 zł</b> <b>705500820</b> · C€
	<ul style="list-style-type: none"> <li>• Front - 205/80R12 - 25" x 8" x 12".</li> <li>• Rear - 270/60R12 - 25" x 10" x 12".</li> </ul>	
<b>ITP Mega Mayhem</b>	G2 X mr 570 & 650 2018 & up G2S X mr 570 2018 & up	<b>705402131</b> · Front <b>997 zł</b> <b>705502645</b> · Rear <b>1 018 zł</b>
	<ul style="list-style-type: none"> <li>• 1.5" tread depth mud thrower tires.</li> <li>• Surprisingly smooth ride on hard pack surfaces.</li> <li>• 6-ply rated.</li> <li>• Front - 28" x 9" x 12".</li> <li>• Rear - 28" x 11" x 12".</li> </ul>	
<b>ITP Cryptid Tire</b>	G2 X mr 850 & 1000R 2018 & up G2S X mr 1000R 2018 & up	<b>705402671</b> <b>1 301 zł</b>
	<ul style="list-style-type: none"> <li>• Graduated lug height and paddle-like shoulder configuration provide maximum side bite for climbing in and out of the mud without compromising ride comfort on trails and hard pack.</li> <li>• 6-ply rated.</li> <li>• 30" x 9" x 14".</li> </ul>	
<b>Gorilla Silverback Tire</b>	G2 (850 & 1000 models only)	<b>705401501</b> <b>1 125 zł</b>
	<ul style="list-style-type: none"> <li>• AT30X9-14 Gorilla Silverback mud tire.</li> <li>• Sold individually.</li> <li>• Not EC compliant.</li> <li>• 30" x 9" x 14".</li> </ul>	
<b>Maxxis Mudzilla Tire</b>	G2 (X mr 570 & 650 models only)	<b>705501836</b> · Rear <b>937 zł</b>
	<ul style="list-style-type: none"> <li>• Not EC compliant.</li> <li>• Rear - 28" x 10" x 12".</li> </ul>	
<b>Kenda Klaw MXR Tire</b>	DS 90 X	<b>V42711DGF01HLL</b> · Front <b>V42712DGF01HLL</b> · Rear
	<ul style="list-style-type: none"> <li>• Front - 20" x 6" x 10".</li> <li>• Rear - 18" x 10.5" x 8".</li> </ul>	

## Rims

### 14" Rim



G2 DPS, G2 XT, G2 MAX  
650, G2 MAX XT, G2 MAX  
Limited

**705401853** - Front **794 zł**  
**705401852** - Front **757 zł**  
**705401851** - Front **738 zł**  
**705502402** - Rear **861 zł**  
**705502401** - Rear **794 zł**  
**705502400** - Rear **794 zł**

■ Black and machined  
■ Black with clear coat  
■ Silver with clear coat  
■ Black and machined  
■ Black with clear coat  
■ Silver with clear coat

- Premium cast aluminum black painted with machining and clear coat rim.
- Center hole: 72 mm.
- Bolt circle pattern:  $\frac{4}{32}$  mm.

- Front - 14" x 6.5" offset = 40 mm.
- Rear - 14" x 8.5" offset = 50 mm.

*Note: Matching Nuts - 250100100 Black, 250100082 Chrome/Matching Cap - 705400928*

### 14" Rim



G2 DPS, G2 XT, G2 MAX  
Limited, G2 North Edition,  
G2 MAX North Edition

**705402309** - Front **738 zł**  
**705402222** - Front **867 zł**  
**705402307** - Front **738 zł**  
**705502770** - Rear **861 zł**  
**705502702** - Rear **892 zł**  
**705502768** - Rear **794 zł**

■ Black and machined  
■ Black with clear coat  
■ Silver with clear coat  
■ Black and machined  
■ Black with clear coat  
■ Silver with clear coat

- Front - 14" x 6.5" offset = 40 mm.
- Rear - 14" x 8.5" offset = 50 mm.

### Outlander X mr and Traxter Rim



X mr models  
front and rear wheels

**705401848** - Front **1 003 zł**  
**705401849** - Front **1 003 zł**

■ Black and machined  
■ Black

- Cast aluminum rim with trend setting explosive styling so you can ride—and look—like a trailblazer.
- Front - 14" x 6.5" offset = 10 mm.

*Note: Matching Nuts - 250100100 Black, 250100082 Chrome/Matching Cap - 705401541*

### Outlander Rim (Camo Model)



G2, G2L, G2S

**705401127** - Front **874 zł**  
**705501493** - Rear **849 zł**

■ Black with clear coat  
■ Black with clear coat

- Black with clear coat aluminum rim.
- Front - 12" x 6" offset = 41 mm.
- Rear - 12" x 7.5" offset = 51 mm.

### 12" Beadlock Rim



G2, G2L, G2S

**705401678** - Front **1 298 zł**  
**705502244** - Rear **1 322 zł**

■ Black  
■ Black

- Black with clear coat aluminum rim.
- Needs 16 bolts (250000787) for installing the beadlock.
- Choice of beadlock color (not included).
- Front - 12" x 6" offset = 41 mm.
- Rear - 12" x 7.5" offset = 51 mm.

### 12" Beadlock Ring



G2, G2L, G2S

**705401763** - ■ Can-Am Red **462 zł** **705401811** - ■ Orange Crush **462 zł**  
**705401810** - ■ Yellow **462 zł** **705401812** - ■ Manta Green **449 zł**

- Cast aluminum beadlock.
- Must be installed on Front Rim (705401678) and Rear Rim (705502244).

*Note: Matching Nuts - 250100184 Black, 250100185 Chrome/Matching Cap - 705400928*

**14" Beadlock Rim**

G2

**705401594** · Front

■ Black

**1 489 zł**

**705503191** · Rear

■ Black

**1 378 zł**



- Black with clear coat aluminum rim.
- Choice of beadlock color (not included).
- Needs 16 bolts (250000787) for installing the beadlock.
- Front - 14" x 6.5" offset = 41 mm.
- Rear - 14" x 8" offset = 51 mm.

**14" Beadlock Ring**

G2

**505 zł**

**705401586** · ■ Manta Green

**705401837** · ■ Can-Am Red

**705401702** · ■ Octane Blue

**705401840** · ■ Black



- Cast aluminum beadlock.
- Must be installed on Front Rim (705401594) and Rear Rim (705503191).

*Note: Matching Nuts - 250100184 Black, 250100185 Chrome/Matching Cap - 705400928*



# TRUST GENUINE CAN-AM PARTS

To keep your vehicle performing at its best.

## BRP 2-YEAR LIMITED WARRANTY\*

Precisely engineered.  
Rigorously tested.  
Factory approved.

The limited warranty is subject to the exclusions, limitations of liabilities and all other terms and conditions of BRP's standard limited warranty. See the complete limited warranty applicable to your product, or contact your authorized Can-Am Off-Road dealer. Applicable only to BRP products purchased at authorized BRP dealers or distributors. This limited warranty may not apply to factory-installed parts and accessories. Always refer to the product-specific limited warranty. Some states and provinces do not allow for some disclaimers, limitations and exclusions and, as a result, you have other specific rights.

# CAN-AM ATVs



To make sure your ATV performs as you expect,  
**keep an eye on these components:\*\***

## OIL FILTER 420256188

### ENGINE OIL\*

#### 4T 10W-50 Synthetic Oil

1 quart / 946 ml 9779234  
1 US gallon / 3.785 L 9779235

#### 4T 0W-40 Synthetic Oil

1 quart / 946 ml 9779139  
1 US gallon / 3.785 L 9779140

#### 4T 5W-40 Synthetic Blend Oil

1 quart / 946 ml 9779133  
1 US gallon / 3.785 L 9779134

### OIL CHANGE KIT\*\*

#### 5W-40 Synthetic Blend Oil

500 cc or more V-twin engine 9779258

#### 0W-40 Synthetic Oil

500 cc or more V-twin engine 9779259

#### 10W-50 Synthetic Oil

500 cc or more V-twin engine 9779252

#### 5W-40 Synthetic Blend Oil

450cc or less 9779256

#### 0W-40 Synthetic Oil

450cc or less 9779257

## FUEL FILTER 709001120

## AIR FILTER

### Performance Air Filter

by Twin Air<sup>1</sup> 715001333

### Premium Air Filter

707800371

## CVT AIR FILTER

### G2S

707001786

### G2, G2L

715003483

## DRIVE BELT

### 450CC & less

Premium (Stock) 422280283

### 500CC & more

Premium (Stock) 422280360

## BRAKE PADS

### Metallic G2

Front & Rear Left 715900248

Front & Rear Right 715900249

### Organic G2, G2L, G2S

(except X mr models)

Front & Rear Left 715601015

Front & Rear Right 715601014

## CV BOOT KITS

### G2, G2L, G2S

(except X mr models)

Front Wheel Side 705401345

Front Differential Side 705401346

Rear 705501864

### X mr models

Front Wheel Side 705401354

Front Differential Side 705401355

Rear 705501864

## WHEEL BEARINGS

293350126

## A-ARM BUSHING KIT

703500875

## BALL JOINTS

Upper

706202044

Lower

706202045

## SPARK PLUG

450, 850, 1000R engines 715900352

570, 650, 1000 engines 715900642

## BATTERY

### G2S, G2, G2L

18 Amps. Wet (YTX20L-BS) 296000444

### DS (250, 90, 70, 50)

13 Amps. Wet

(YTX16L-BS)

V31500MAA020

\* For Europe, please check correspondent part numbers on page 56.

\*\*Refer to periodic maintenance chart for proper intervals.

Cennik zawiera sugerowane ceny detaliczne brutto w walucie PLN. Ceny mogą ulec zmianie bez wcześniejszego uprzedzenia. Cennik nie jest ofertą w rozumieniu prawa.

# GENUINE PARTS

## Oil Filters

Oil Filters	Models	Oil Filter	Sealing Ring (Oil Filter Cover)	Sealing Ring (Drain Plug)
	Maverick	<b>4209561 23</b>	<b>420230923</b>	<b>420552280</b>
	Maverick Trail & Sport	<b>4202561 88</b>	<b>420230923</b>	<b>420552280</b>
	G2S, G2 & G2L	<b>4202561 88</b>	<b>420230923</b>	<b>420552280</b>

Complete Engine Oil Change Kit also available — see page 56

## Air Filters

Premium Air Filter	Models	
	Traxter/Traxter MAX	<b>715900394</b>
	Maverick	<b>715900422</b>
	Maverick Trail & Sport (Engines 700 & 1000)	<b>715900394</b>
	Maverick Trail & Sport (Engine 1000R)	<b>715900422</b>
	G2S, G2 & G2L	<b>707800371</b>

- Premium quality filter.
- Prevents airborne contaminants from reaching your engine.
- Protects internal components against premature wear.

Performance Air Filter by Twin Air <sup>†</sup>	Models	
	Maverick	<b>715002895</b>
	Maverick Trail & Sport	<b>715002895</b>
	G2S, G2 & G2L	<b>715001333</b>

- The best choice for the harshest conditions.
- Multiple staged oiled filtering foam for superior dust retaining capacity with high air flow.
- Washable and reusable.

CVT Air Filter (Not illustrated)	Models	
	Traxter/Traxter MAX (except X mr)	<b>706600419</b>
	Maverick	<b>706600416</b>
	Maverick Trail & Sport (except X mr)	<b>706600417</b>
	Maverick Trail & Sport X mr	<b>706600418</b>
	G2, G2L	<b>715003483</b>
	G2S	<b>707001786</b>

## Spark Plug

Spark Plug	Models	
	Traxter HD10	715900244
	Traxter HD9	715900642
	Traxter HD7	715900785
	Maverick and Maverick Turbo RR	415130363
	Maverick Trail & Sport 1000R	715900244
	Maverick Trail & Sport 1000	715900642
	Maverick Trail 700	715900785
	ATV 450/850/1000R	715900352
	ATV 570/650/1000	715900642

## Batteries

### Yuasa† Batteries

• Top of the line models from the leading preferred original equipment battery supplier in North America.



Models	3 A Wet (YTX4L-BS)	10 A Wet (YTX12-BS)	18 A Wet (YTX20L-BS)	30 A, requires Battery Holder (715004431)
Traxter/Traxter MAX	—	—	296000444	515176151 Except Base and DPS models.
Maverick	—	—	296000444	—
Maverick Trail & Sport	—	—	296000444	—
G2S, G2 & G2L	—	—	296000444	—
DS 50, 70 & 90	V31500MAA020	—	—	—
Renegade 70,110	V31500MAA020	—	—	—
DS 250	—	715900031	—	—

## Axles

### Premium CV Axle

- Premium quality design ideal for off-roading, heavy-duty and low speed torque usage.
- Includes CVs, shaft and boots with the best suited geometry for your Can-Am vehicle.



Models	Front Left	Front Right	Rear
Traxter MAX	705401937	705401936	705502451
Traxter XT-P	705402353	705402353	705502451
Traxter HD10	705401937	705401936	705502451
Traxter HD9	705401937	705401936	705502451
Traxter HD7	705401937	705401936	705502478 (L) 705502479 (R)
Maverick Sport (ABS)	705402443	705402443	705502756
Maverick Sport Base, DPS	705402031	705402030	705502552
Maverick Trail (W/O ABS)	705402008	705402007	705502541
Maverick Trail (ABS)	705402442	705402442	705502755

All ATVs: Please contact your dealer or visit our online store at [can-amoffroad.com](http://can-amoffroad.com) for suggested fitment.

### Performance CV Axle

(Not illustrated)

- High-performance design ideal for off-road use with superior wheel power and acceleration for racing, dunes, trails and desert riding.
- Includes CVs, shaft and boots with the best suited geometry for your Can-Am vehicle.

Models	Front Left	Front Right	Rear
Traxter X mr	705402420	705402420	—
Maverick Sport X mr/X rc	705402282	705402282	705502757

## Brakes

### Metallic Brake Pad Kit

- Built strong to last long – heavy-duty construction stands up to hard braking.
- Designed to handle demanding riding conditions with challenging braking environments such as mud and dunes.
- Created specifically for use with Can-Am vehicles.



Models	Front Left	Front Right	Rear Left	Rear Right
Traxter MAX HD9/HD10	715900379	715900380	715900386	715900387
Traxter HD10	715900379	715900380	715900381	715900382
Traxter HD9	715900379	715900380	715900381	715900382
Traxter HD7	715900379	715900380	—	715900387
Maverick	715900379	715900380	715900386	715900387
Maverick Trail & Sport	715900379	715900380	715900386	715900387
G2S, G2 & G2L	715900248	715900249	715900248	715900249

Please contact your dealer or visit our online store at [Can-Amoffroad.com](http://Can-Amoffroad.com) for suggested fitment.

## Parts

### A-Arm Bushing Kit

703500875

- This bushing kit includes 2 bushings, a sleeve and a wear plate, as illustrated.
- All you need to renew your suspension A-Arms.



### Ball Joints

- Robust design for off-road usage and sealed for prolonged durability.



Upper

706202044

Upper (Maverick, Trail & Sport)

706203084

Lower

706202045

### Wheel Bearings

(Not illustrated)

- Sealed bearings for additional protection from water and dirt.

2020 models and prior

293350118

2021 & up models

293350126

Maverick

293350141

### CV Boot Kit

- Comes with clamps and grease.
- Genuine BRP CV Boot Kits ensure absolute compatibility and a perfect fit.



Models	Front Wheel Side	Front Differential Side	Rear Wheel & Differential Side
Traxter	705401345	705401355	705501864
Maverick	705401354	705401354	715900450
Maverick Sport (ABS, X xc, X mr, X rc)	705401354	705401355	705501864
Maverick Sport (w/o ABS), Maverick Trail	705401345	705401355	705501864
G2, G2L, G2S (except X mr)	705401345	705401346	705501864
X mr	705401354	705401355	705501864

## Belts

### BRP Premium Drive Belt

- High-performance design ideal for off-road use.
- BRP-specific calibration adjusted to best suit your Can-Am vehicle.



Models	Premium Belt	CVT Gasket Cover	Upgrades
Traxter HD10	422280652	420450400	—
Traxter HD9	422280656	420450400	422280652
Traxter HD7	422280225	—	—
Maverick	422280652	420450405	—
Maverick Trail & Maverick Sport 1000	422280656	420450400	422280652
Maverick Trail 700	422280225	—	—
G2, G2S 450 CC & less	422280283	420430126	—
G2, G2S 500 CC & more	422280366	420430126	—
G2L Outlander 450 & Outlander MAX 450	422280283	420630292	—

### Driven Pulley Adapter Tool

(Not illustrated)

- Spreads the secondary clutch open for easy belt replacement.

### Puller/Locking Tool

(Not illustrated)

- Allows you to spread the secondary clutch open for easy belt replacement.

Models	Driven Pulley Adapter	Puller/Locking Tool
Traxter HD10-HD9	708200720	529000088
Traxter HD7	—	529036098
Maverick Trail & Sport	708200720	529000088
Maverick	708200720	529000088
G2, G2S	—	529036098
G2L Outlander 450 & Outlander MAX 450	—	529036098

## pDrive Pulley Service kits

### Ramp Roller Maintenance Set

SSV pDrive (MY22)  
SSV pDrive (MY23)

420629231  
Coming winter 2023

pDrive Ramp Roller Set



### Torque Roller Maintenance Set

SSV pDrive (MY22)  
SSV pDrive (MY23)

420629224  
Coming winter 2023

pDrive Torque Roller Set



# LUBRICANT & OIL CHANGE KIT

## Lubricant

### XPS 4T 10W-50 Synthetic Oil

9779234 · 1 qt / 946 ml US  
9779240 · EU

9779235 · 1 US gal / 3.785 L



- Engineered for heavy-duty and high-performance 4-stroke engines, including turbocharged, supercharged and racing engines.
- Formulated using carefully selected and strenuously tested base stocks and custom additives.
- Offers thick film strength to protect bearings, and a proven high-temp detergency to minimize deposits, prevent shear, provide thermal stability, and combat fuel dilution to ensure maximum performance from your engine.

### XPS 4T 0W-40 Synthetic Oil

9779139 · 1 qt / 946 ml US  
9779286 · EU

9779140 · 1 US gal / 3.785 L US  
9779287 · EU



- Powersport formula with premium anti-wear and anti-corrosion additives.
- The best choice for high-performance snowmobile, ATV and SXS 4-stroke engines used in cold weather.
- Provides superior engine and transmission protection against heat, rust and corrosion.
- Delivers optimal performance in high and low temperatures.

### XPS 4T 5W-40 Synthetic Blend Oil

9779133 · 1 qt / 946 ml US  
9779290 · EU

9779134 · 1 US gal / 3.785 L US  
9779291 · EU



- Off-road formula with premium anti-wear and anti-corrosion additives.
- Designed for high-performance off-road, on-road and PWC 4-stroke engines, including turbo or supercharged powersports engines.
- Provides superior engine and transmission protection against rust and corrosion, even in extreme conditions.

## Oil Change Kit

### Engine Oil Change Kit

#### Models



- Ultra-convenient "all-in-one" Engine Oil Change Kit saves time and money.
- Includes XPS Synthetic or Synthetic Blend Oil, oil filter, O-rings and washer.

5W-40 Synthetic Blend Oil / 450cc or less	9779256 · US 9779408 · EU
0W-40 Synthetic Oil / 450cc or less	9779257 · US 9779409 · EU
5W-40 Synthetic Blend Oil / 500 cc or more V-twin engine	9779258 · US 9779405 · EU
0W-40 Synthetic Oil / 500 cc or more V-twin engine	9779259 · US 9779406 · EU
10W-50 Synthetic Oil / 500 cc or more V-twin engine	9779252 · US 9779401 · EU
5W-40 Synthetic Blend Oil / 900 ACE	9779260 · US 9779410 · EU
10W-50 Synthetic Oil / 900 ACE	9779261 · US 9779411 · EU



# MAINTENANCE PRODUCTS

## Synthetic Gear Oil



75W-90

75W-140

**9779158** · 1 qt / 946 ml US

**9779212** · EU

**9779160** · 1 qt / 946 ml US

**9779215** · EU

- Uses custom additives to provide the best performance in Visco-Lok™ and Smart-Lok™ differentials.
- Allows higher loads, superior shear stability and reduced oxidation.
- Exceptional wear protection and superior performance at all operating temperatures.

## Extended Life Pre-Mixed Coolant



**9779150** · 1 qt / 946 ml

**619590204** (Scandinavia)

- Antifreeze/coolant contains the correct dilution and the necessary additives to prevent corrosion and inhibit cavitation in BRP cooling systems.
- Long-life, 5-year formula specially formulated for BRP vehicles.
- Superior heat transfer.
- Ideal replacement for vehicles that normally use a 2-year antifreeze/coolant (green).
- 5 years (orange).

## Anti-Corrosive Lubricant



**9779167** · 12 oz / 340 g

**619590722** (Scandinavia)

- Multipurpose lubricant that can also be used to prevent rust, corrosion and moisture intrusion.
- It contains extreme pressure additives that work as an all-around lubricant for just about anywhere lubrication is needed.

## DOT 4 Brake Fluid



**9779151** · 12 fl oz / 355 ml US

**9779207** · EU

- Meets or exceeds all DOT3 and DOT4 brake fluid requirements.
- High-temperature formula resists fade and also conditions seals and O-rings in braking system.

# CARE PRODUCTS

## Cleaner and Degreaser, All Purpose

9779328 · 22 fl oz / 650 ml

9779329 · 2 qt / 1.89 L



- Ready-to-use formula.
- Cleans toughest dirt and grime.
- Phosphate free eco-friendly formula.
- Low-foam easy rinse formula.

## Matte Finish Waterless Cleaner

9779330 · 22 fl oz / 650 ml



- Easy waterless use.
- Perfect for matte, flat and denim surfaces.
- Contains no wax or silicone.
- Leaves no unwanted streaks or marks.

## Multi-Surface and Glass Cleaner

9779331 · 22 fl oz / 650 ml



- Easy waterless spray and wipe use.
- Polymer formula cleans and protects.
- Contains no wax or silicone.
- Leaves no unwanted streaks or marks.

## Mud and Dust Off-Road Wash

9779340 · 33 fl oz / 946 ml

9779341 · 2 qt / 1.89 L



- Specially formulated for off-road vehicles, it breaks the bond holding grime and dirt to your vehicle's finish.
- The formula is biodegradable, eco-friendly with no phosphates or corrosive chemicals and is low foam for easy, quick rinsing.
- Effective on oil, grease and other stubborn grime.
- Safe for use on all surfaces.

## Black Plastic and Rubber Restorer

9779335 · 7.6 fl oz / 225 ml



- Restores plastic, rubber and vinyl.
- Long-lasting formula.
- Protects against UV rays.

## Foaming Wash

9779337 · 16 fl oz / 473 ml

9779338 · 2 qt / 1.89 L



- Concentrated formula for off-road vehicles, it produces a thick foam to lift dirt and prevent scratching.
- The pH neutral formula is safe for wax and paint sealants.
- Works in pressure washers or by hand.

## Quick Detailer Gloss Enhancing

9779332 · 4 fl oz / 118 ml

9779333 · 16 fl oz / 473 ml



- Quick detail spray wax.
- Leaves a high gloss finish at every wipe.
- Nanotechnology polymer formula.
- Repels dirt.
- No water needed.

EXPLORE AN ENTIRE WORLD OF ADVENTURE WITH ALL OF OUR BRP PRODUCTS. [BRP.COM](http://BRP.COM)



*ski-doo* *LYNX* *SEA-DOO* *CAN-AM* *ROTAX* *ALUMACRAFT* *Manitou* *QUINTREX*

---



[CAN-AMOFFROAD.COM](http://CAN-AMOFFROAD.COM)

A BRP BRAND

